

**Centre Scientifique et  
Technique du Bâtiment**

84 avenue Jean Jaurès  
CHAMPS-SUR-MARNE  
F-77447 Marne-la-Vallée Cedex 2

Tél. : (33) 01 64 68 82 82

Fax : (33) 01 60 05 70 37

**European Technical  
Evaluation**

**ETA-12/0261  
of 08/12/2015**

*English translation prepared by CSTB - Original version in French language*

**General Part**

Nom commercial  
*Trade name*

**G&B Fissaggi GX-L**

Famille de produit  
*Product family*

**Cheville plastique pour usage multiple dans le béton et la  
maçonnerie pour applications non structurales**  
***Plastic anchor for multiple use in concrete and masonry for  
non-structural applications***

Titulaire  
*Manufacturer*

G&B Fissaggi S.r.l.  
Corso Savona, 22  
10029 Villastellone (TO)  
Italy

Usine de fabrication  
*Manufacturing plants*

G&B Fissaggi S.r.l.  
Corso Savona, 22  
10029 Villastellone (TO)  
Italy

Cette évaluation contient:  
*This Assessment contains*

13 pages incluant 9 annexes qui font partie intégrante de  
cette évaluation  
*13 pages including 9 annexes which form an integral part of  
this assessment*

Base de l'ETE  
*Basis of ETA*

ETAG 020, Version Mars 2012, utilisée en tant que EAD  
*ETAG 020, Edition Mars 2012 used as EAD*

Cette évaluation remplace:  
*This Assessment replaces*

ATE-12/0261 valide du 14/06/2012 au 14/06/2017  
ETA-12/0261 with validity from 14/06/2012 to 14/06/2017

## Specific Part

### 1 Technical description of the product

The G&B Fissaggi GX-L is an anchor consisting of a special screw and a polymeric sleeve which passes through the fixture. The special screw is made of galvanized steel or stainless steel, whereas the sleeve consists of polyamide PA6. The polymeric sleeve is expanded by screwing in the expansion element which presses the sleeve against the wall of the drilled hole.

The installed anchor is shown in Annex A.

### 2 Specification of the intended use

The performances given in Section 3 are only valid if the anchor is used in compliance with the specifications and conditions given in Annexes B.

The provisions made in this European Technical Approval are based on an assumed working life of the anchor of 50 years. The indications given on the working life cannot be interpreted as a guarantee given by the producer, but are to be regarded only as a means for choosing the right products in relation to the expected economically reasonable working life of the works.

### 3 Performance of the product

#### 3.1 Mechanical resistance and stability (BWR 1)

For Basic Requirement *Mechanical resistance and stability* the same criteria are valid as for Basic Requirement *Safety in use*.

#### 3.2 Safety in case of fire (BWR 2)

Essential characteristic	Performance
Reaction to fire	Anchorage satisfy requirements for Class A1
Resistance to fire	See Annex C1

#### 3.3 Hygiene, health and the environment (BWR 3)

Regarding dangerous substances contained in this European technical approval, there may be requirements applicable to the products falling within its scope (e.g. transposed European legislation and national laws, regulations and administrative provisions). In order to meet the provisions of the Construction Products Directive n°305/2011, these requirements need also to be complied with, when and where they apply.

#### 3.4 Safety in use (BWR 4)

Essential characteristic	Performance
Characteristic Resistances of the screw for tension and shear loads and bending moments in concrete and masonry	See Annex C1
Characteristic Resistance of the plastic expansion sleeve in concrete	See Annex C1
Characteristic Resistance of the plastic expansion sleeve in masonry	See Annex C1
Displacements	See Annex C3
Anchor distances and dimensions of members	See Annex B2, B3

**3.5 Protection against noise (BWR 5)**

Not relevant.

**3.6 Energy economy and heat retention (BWR 6)**

Not relevant.

**3.7 Sustainable use of natural resources (BWR 7)**

For the sustainable use of natural resources no performance was determined for this product.

**3.8 General aspects relating to fitness for use**

Durability and Serviceability are only ensured if the specifications of intended use according to Annex B1 are kept.

**4 Assessment and verification of constancy of performance (AVCP)**

According to the Decision 97/463/EC of the European Commission<sup>1</sup>, as amended, the system of assessment and verification of constancy of performance (see Annex V to Regulation (EU) No 305/2011) given in the following table apply.

Product	Intended use	Level or Class	System
Plastic anchor for use in concrete and masonry	Plastic anchor for multiple use in concrete and masonry for non-structural applications	—	2+

**5 Technical details necessary for the implementation of the AVCP system**

Technical details necessary for the implementation of the Assessment and verification of constancy of performance (AVCP) system are laid down in the control plan deposited at Centre Scientifique et Technique du Bâtiment.

The manufacturer shall, on the basis of a contract, involve a notified body approved in the field of anchors for issuing the certificate of conformity CE based on the control plan.

Issued in Marne La Vallée on 08-12-2015 by  
Charles Baloche  
Directeur technique

*The original French version is signed*

---

<sup>1</sup> Official Journal of the European Communities L 254 of 08.10.1996

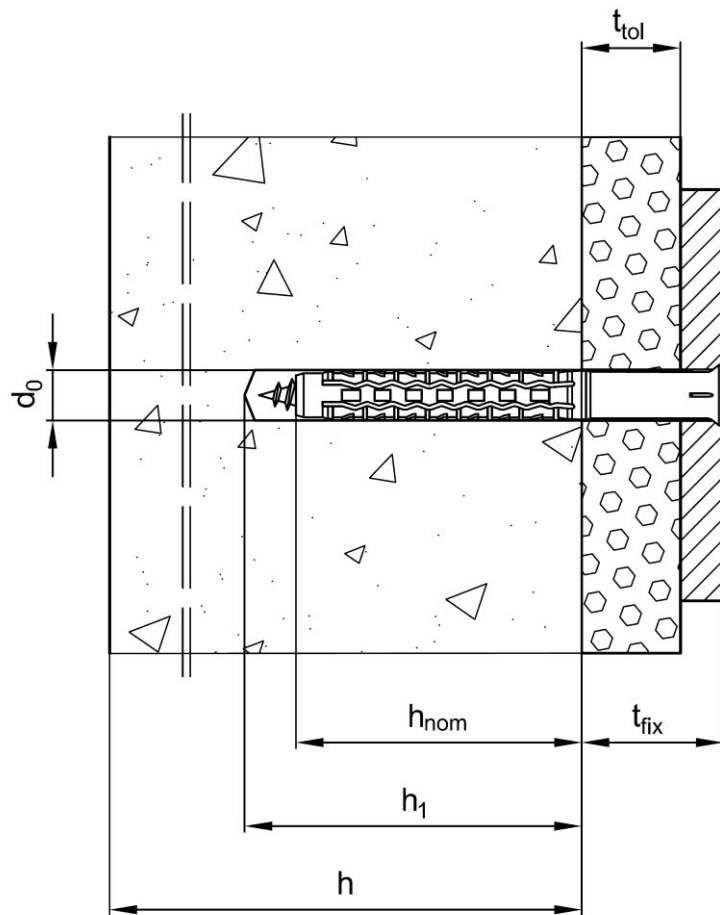

**Legend:**

- $d_0$  = drill hole diameter
- $h_{nom}$  = overall plastic anchor embedment depth in the base material
- $h_1$  = depth of the drilled hole to deepest point
- $h$  = thickness of member
- $t_{tol}$  = thickness of the nonstructural coating
- $t_{fix}$  = thickness of the fixture

**G&B Plastic anchor GX-L**

**Product description**

Installed condition

**Annex A1**

Expansion sleeve of GX-L anchor

Version with collar

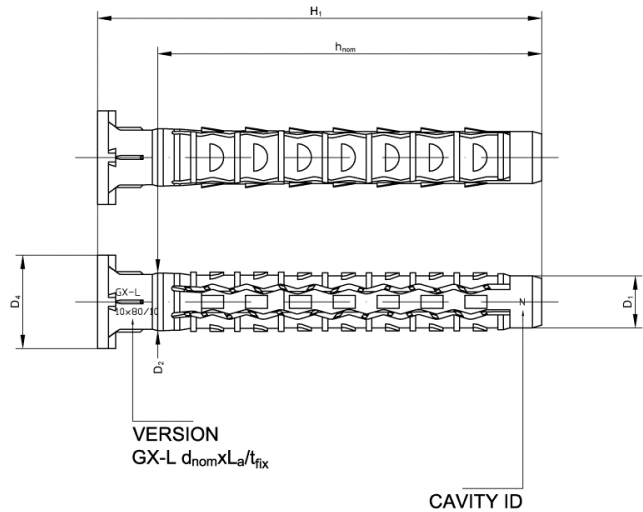
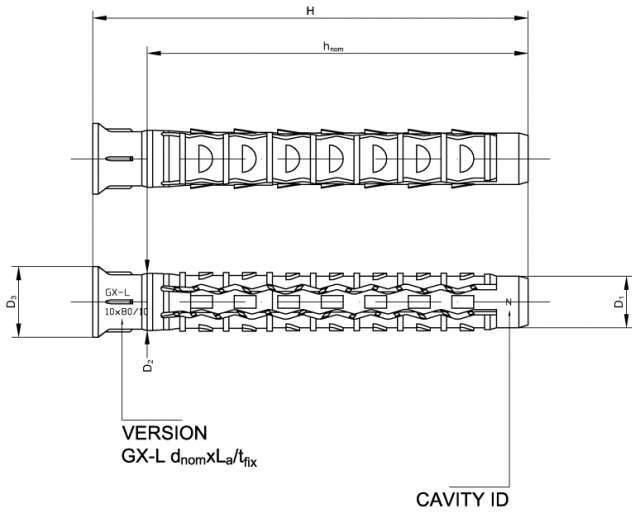

Version with collar for size  $\phi 10$  only

Special screws

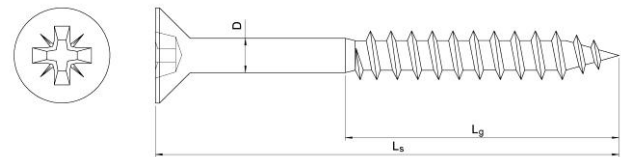
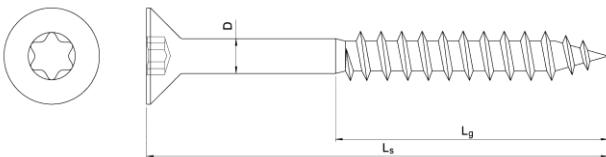

Torx

PZ

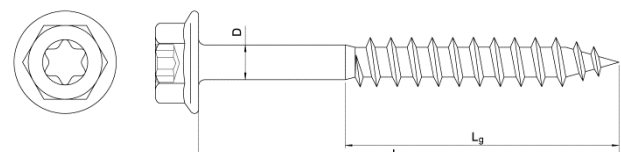
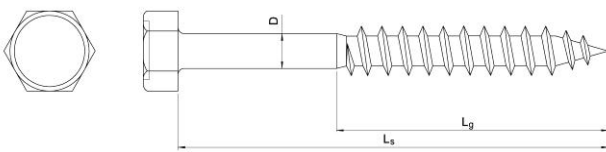

HEX

HEX Flanged head

G&B Plastic anchor GX-L

Product description

Expansion sleeve, marking, anchor type and special screws

Annex A2

**Table 1 : Materials**

Designation	Material
Plastic sleeve	Polyamide PA6, Light grey
Special screw	Carbon steel, Grade 5.8, Galvanized acc. ISO 4042 Carbon steel, Grade 5.8, Hot dip galvanized acc. ISO 10684 Stainless steel AISI 316; 1.4401

**Table 2: Dimensions**

Anchor type	Plastic sleeve								Screw						
	d <sub>nom</sub>	h <sub>nom</sub>	D <sub>1</sub>	D <sub>2</sub>	D <sub>3</sub>	D <sub>4</sub>	t <sub>fix,max</sub>	H	D	L <sub>s</sub>	L <sub>g</sub>	Torx	PZ	HEX	HEX Torx Flanged
8x80/10	8	70	7,8	8,5	10,5	-	10	80	5,5	85	55	x	x	x	-
8x100/30							30	100		105		x	x	x	-
8x120/50							50	120		125		x	x	x	-
8x140/70							70	140		145		x	x	x	-
8x170/100							100	170		175		x	x	x	-
8x200/130							130	200		205		x	x	x	-
10x80/10	10	70	9,5	10,5	13,0	17,0	10	80	7,0	85	58-85	x	x	x	x
10x100/30							30	100		105	63-85	x	x	x	x
10x120/50							50	120		125	63-85	x	x	x	x
10x140/70							70	140		145	63-85	x	x	x	x
10x160/90							90	160		165	63-85	x	x	x	x
10x200/130							130	200		205	63-85	x	x	x	x
10x240/170							170	240		245	80-85	x	x	x	x
10x260/190							190	260		260	80-85	x	x	x	x

**Denomination:**

GX-L d<sub>nom</sub> x L<sub>a</sub> / t<sub>fix</sub> : GX-L 8x80/10

**G&B Plastic anchor GX-L**

**Product description**

Dimensions, Materials, Installation parameters

**Annex A3**

## Specifications of intended use

### Anchorage subject to:

- Static and quasi-static loads,
- Multiple fixing for non-structural applications.

### Base materials:

- Use category « a » : Reinforced or unreinforced normal weight concrete, cracked or non-cracked, with strength class  $\geq$  C12/15, according to EN 206: 2000-12 ;
- Use category « b » : solid masonry according to Annex C2 ;
- Use category « c » : hollow or perforated masonry according to Annex C2 .
- Mortar strength class of the masonry  $\geq$  M 2,5 according to EN 998-2-2010.
- For other base materials of the use categories « a », « b » or « c », the characteristic resistance of the anchor may be determined by job site tests according to ETAG020, Annexe B, Edition march 2012.

### Temperature range:

- a : -20 °C to + 40°C  
(max. short term temperature +40°C et max. long term temperature +24°C)

### Use conditions (Environmental conditions):

- Structures subject to dry internal conditions (zinc coated steel, stainless steel),
- The specific screw made of galvanized steel may only be used in structures subject to dry internal conditions. These screws may also be used in structures subject to external atmospheric exposure, if the area of the head of the screw is protected against moisture and driving rain after mounting of the fixing unit in such way, that intrusion of moisture into the anchor shaft is prevented. Therefore there shall be an external cladding or a ventilated rainscreen mounted in front of the head of the screw and the head of the screw itself shall be coated with a soft plastic, permanently elastic bitumen-oil-combination coating (e. g. undercoating or body cavity protection for cars).
- Structures subject to permanently damp internal conditions or to external atmospheric exposure including industrial and marine environment if no particular aggressive conditions exist (stainless steel).

*Note: Note: Particular aggressive conditions are e.g. permanent, alternating immersion in seawater or the splash zone of seawater, chloride atmosphere of indoor swimming pools or atmosphere with extreme chemical pollution (e.g. in desulphurization plants or road tunnels where de-icing materials are used).*

### Design:

- The design of anchorages is carried out in compliance with ETAG 020, Guideline for European Technical Approval of "Plastic Anchors for Multiple Use in Concrete and Masonry for non-structural Applications", Annex C under the responsibility of an engineer experienced in anchorages.
- Verifiable calculation notes and drawings shall be prepared taking account of the loads to be anchored, the nature and strength of the base materials and the dimensions of the anchorage members as well as of the relevant tolerances. The position of the anchor is indicated on the design drawings.
- The anchor is to be used only for multiple fixing for non-structural applications. according to ETAG 020 Edition March 2012 .

**G&B Plastic anchor GX-L**

**Intended Use**  
Specifications

**Annex B1**

**Installation:**

- Anchor installation carried out by appropriately qualified personnel and under the supervision of the person responsible for technical matters on the site.
- Use of the anchor only as supplied by the manufacturer without exchanging the components of an anchor.
- Anchor installation in accordance with the manufacturer's specifications and drawings prepared for that purpose and using the appropriate tools.
- Checks before placing the anchor to ensure that the characteristic values of the base material in which the anchor is to be placed are identical to the values to which the characteristic loads apply;
- Observation of the drilling method using rotary drilling or hammer / impact drilling as given in Annex C2 (drill bits acc. to ISO 5468).
- Placing drilled holes without damaging the reinforcement;
- Holes to be cleaned of drilling dust
- In case of aborted hole: new drilling at a minimum distance away of twice the depth of the aborted hole or smaller distance if the aborted drill hole is filled with high strength mortar.
- The plastic sleeve is inserted through the fixture by slight hammer blows and the special screw is screwed in until the head of the screw touches the sleeve. The anchor is correct mounted, if there is no turn-through of the plastic sleeve in the drill hole and if slightly move is impossible after the complete turn-in of the screw.
- Temperature during the installation of the anchor  $\geq 0^{\circ}\text{C}$ ;
- Protection to UV exposure due to solar radiation of the anchor not protected.

**G&B Plastic anchor GX-L**

**Intended Use**  
Specifications

**Annex B1**



**Table 3: Installation Parameters**

Dénomination		GX-L 8	GX-L 10
Drill hole diameter	$d_0 =$ [mm]	8	10
Cutting diameter of drill bit	$d_{cut} =$ [mm]	[8,25 – 8,45]	[10,25 – 10,45]
Depth of drill hole to deepest point	$h_1 \geq$ [mm]	80	80
Plastic anchor embedment depth in the base material	$h_{nom} \geq$ [mm]	70	70
Diameter of the clearance hole in the fixture	$d_f \leq$ [mm]	8,5	10,5

**Table 4: Minimum thickness of member, edge distance and anchor spacing in concrete**

Anchor size	Concrete	$h_{min}$	$C_{cr,N}$	$C_{min}$	$S_{min}$
		[mm]	[mm]	[mm]	[mm]
GX-L 8	Concrete C12/15	100	100	70	70
	Concrete $\geq$ C16/20	100	70	50	50
GX-L 10	Concrete C12/15	100	140	70	85
	Concrete $\geq$ C16/20	100	100	50	60

Scheme of distance and spacing

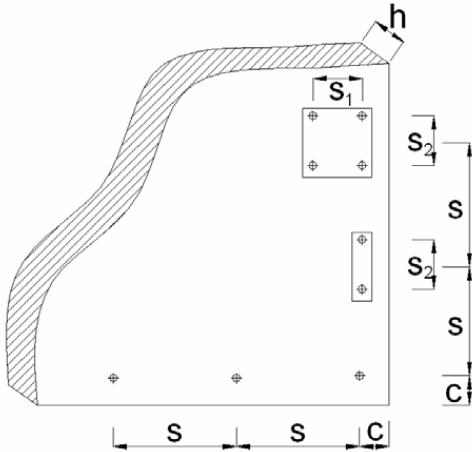

**G&B Plastic anchor GX-L**

Installation parameters (concrete and masonry)  
 Minimum member thickness, edge distance and spacing in concrete

**Annex B2**

**Table 5: Minimum thickness of member, edge distance and anchor spacing in masonry for GX-L 8 and GX-L 10**

Base material	Minimum thickness of member $h_{min}$ [mm]	Edge distance $c_{min}$ [mm]	Spacing		
			Single anchor $s_{min}$ [mm]	Anchor group	
				Perpendicular to free edge $s_{1,min}$ [mm]	Parallel to free edge $s_{2,min}$ [mm]
Solid clay brick, EN 771-1	115	100	250	200	400
Solid sand-lime brick, EN 771-2	115	100	250	200	400
Vertically perforated clay brick, EN 771-1 <i>e.g.: Wienerberger Doppio Uni</i>	115	100	250	200	400
Hollow clay brick, EN 771-1 <i>e.g.: Imerys Optibric PV</i>	200	100	250	200	400
Vertically perforated clay brick, EN 771-1 <i>e.g.: Bergmann HLZ 12</i>	115	100	250	200	400
Sand-lime perforated brick, KSL-R 8DF or DIN 106 / EN 771-2	240	100	250	200	400

- 1) Information for base material masonry: see Annex C2 , Table 9.
- 2) The design method is valid for single anchors and anchor groups with two or four anchors.
- 3) For edge distance  $c \geq 200$  mm in hollow or perforated masonry (use category "c") the values for spacing only may be reduced to  $s_{1,min} = s_{2,min} = 100$  mm, , if the characteristic resistance for an anchor group  $F_{Rk}$  according to Table 9 of Annex C2 is reduced with the factor 0,5. Intermediate values by linear interpolation.

Scheme of distances and spacing

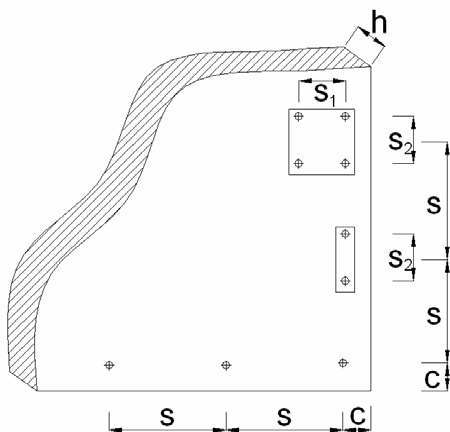

**G&B Plastic anchor GX-L**

**Minimum thickness, edge distances and spacings in masonry**

**Annex B3**

**Table 6: Characteristic resistance of the screw for use in concrete and masonry**

Designation		Galvanized steel		Stainless steel	
		GX-L 8	GX-L 10	GX-L 8	GX-L 10
Screw diameter	$d_s$ [mm]	5,5	7,0	5,5	7,0
Characteristic tension resistance	$N_{Rk,s}$ [kN]	9,6	12,8	6,0	12,3
Partial safety factor	$\gamma_{Ms}^{1)}$ [-]	1,50	1,49	2,86	2,86
Characteristic shear resistance	$V_{Rk,s}$ [kN]	4,8	6,4	3,0	6,2
Partial safety factor	$\gamma_{Ms}^{1)}$ [-]	1,25	1,50	2,38	2,38
Characteristic bending resistance	$M_{Rk,s}$ [Nm]	5,6	10,7	3,5	10,3
Partial safety factor	$\gamma_{Ms}^{1)}$ [-]	1,25	1,50	2,38	2,38

<sup>1)</sup> In absence of other national regulations

**Table 7: Characteristic resistance of the plastic sleeve for use in concrete**

Pull-out failure		GX-L 8	GX-L 10
Characteristic resistance, concrete $\geq$ C16/20	$N_{Rk,p}$ [kN]	2,0	3,0
Characteristic resistance, concrete C12/15	$N_{Rk,p}$ [kN]	1,2	2,0
Partial safety factor	$\gamma_{Mc}^{1)}$ [-]	1,8	1,8

<sup>1)</sup> In absence of other national regulations

**Table 8: Concrete cone failure and concrete edge failure for single anchor and anchor group**

Tension load <sup>2)</sup>	
$N_{Rk,c} = 7,2 \sqrt{f_{ck,cube}} \cdot h_{ef}^{1,5} \cdot \frac{c}{c_{cr,N}} = N_{Rk,p} \cdot \frac{c}{c_{cr,N}}$	with $h_{ef}^{1,5} = \frac{N_{Rk,p}}{7,2 \cdot \sqrt{f_{ck,cube}}}$ et $\frac{c}{c_{cr,N}} \leq 1$
Shear load <sup>2)</sup>	
$V_{Rk,c} = 0,45 \cdot \sqrt{d_{nom}} \cdot (h_{nom}/d_{nom})^{0,2} \cdot \sqrt{f_{ck,cube}} \cdot c_1^{1,5} \cdot \left(\frac{c_2}{1,5c_1}\right)^{0,5} \cdot \left(\frac{h}{1,5c_1}\right)^{0,5}$ avec: $\left(\frac{c_2}{1,5c_1}\right)^{0,5} \leq 1$ et $\left(\frac{h}{1,5c_1}\right)^{0,5} \leq 1$	
$c_1$ Edge distance closest to the edge in loading direction	
$c_2$ Edge distance perpendicular to direction 1	
$f_{ck,cube}$ Nominal characteristic concrete compression strength (based on cubes), value for C50/60 at most	
Partial safety factor	$\gamma_{Mc}^{1)}$ 1,8

<sup>1)</sup> In absence of other national regulations

<sup>2)</sup> The design according to ETAG020, Annex C shall be used





According to the Technical Report TR 020 "Evaluation of anchorages in concrete concerning resistance to fire" it can be assumed that, for fastening of facade systems, the load bearing behavior of the GX-L 10 has a sufficient resistance to fire of at least 90 minutes (R90) if the admissible load  $F_{Rk} / (\gamma_M \cdot \gamma_F)$  is  $\leq 0,8$  kN (no permanent centric tension load).

**G&B Plastic anchor GX-L**

**Characteristic resistance in concrete**

**Annex C1**

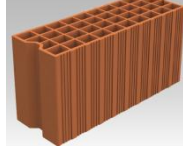
**Table 9: Characteristic resistance in masonry**

Base material	Picture / Measures [mm]	Drill method <sup>1)</sup>	Density class [kg/dm <sup>3</sup> ]	Compressive strength class [N/mm <sup>2</sup> ]	F <sub>rk</sub> <sup>2)</sup> [kN]	
					GX-L 8	GX-L 10
Solid clay brick, EN 771-1	 247x118x73	P	>2,1	f <sub>b</sub> ≥ 75 <sup>3)</sup>	3,5	4,0
				f <sub>b</sub> ≥ 20 <sup>3)</sup>	1,5	1,2
Solid sand-lime brick, EN 771-2	 240x114x71	P	>1,9	f <sub>b</sub> ≥ 30 <sup>3)</sup>	1,5	2,5
Vertically perforated clay brick, EN 771-1 <i>e.g.: Wienerberger Doppio Uni</i>	 120x250x120	P	>0,91	15	0,5	0,75
Hollow clay brick, EN 771-1 <i>e.g.: Imerys Optibric PV</i>	 560x200x274	R	>0,60	7,5	0,3	0,5
Vertically perforated clay brick, EN 771-1 <i>e.g.: Bergmann HLZ 12</i>	 240x115x113	P	>0,90	12	0,5	0,9
Sand-lime perforated brick, KSL-R 8DF DIN 106 / EN 771-2	 250x240x238	P	>1,3	15	0,5	1,2
Partial safety factor	γ <sub>Mm</sub> <sup>4)</sup>	2,5				

<sup>1)</sup> H= Hammer drilling; R= Rotary drilling

<sup>2)</sup> Characteristic resistance F<sub>rk</sub> for tension, shear or combined tension and shear loading.  
 The characteristic resistance is valid for single plastic anchor or for a group of two or four plastic anchors with a spacing equal or larger than the minimum spacing s<sub>min</sub> according to Table 5, Annex B3.

<sup>3)</sup> f<sub>b</sub> = minimum mean compressive strength.

<sup>4)</sup> In absence of other national regulations.

**G&B Plastic anchor GX-L**

**Annex C2**

**Characteristic resistance in masonry**

**Table 10: Displacement under tension / shear loading in concrete**

Anchor size	Tension load			Shear load		
	F [kN]	$\delta_{N0}$ [mm]	$\delta_{N\infty}$ [mm]	F [kN]	$\delta_{N0}$ [mm]	$\delta_{N\infty}$ [mm]
<b>GX-L 8</b>	0,79	0,46	0,21	1,14	0,74	1,11
<b>GX-L 10</b>	1,19	0,35	0,47	1,71	1,57	2,35

**Table 4: Displacements under tension / shear loading in masonry**

Base material <sup>1)</sup>	Displacement									
	GX-L 8					GX-L 10				
	F [kN]	Tension		Shear		F [kN]	Tension		Shear	
	$\delta_{N0}$	$\delta_{N\infty}$	$\delta_{V0}$	$\delta_{V\infty}$		$\delta_{N0}$	$\delta_{N\infty}$	$\delta_{V0}$	$\delta_{V\infty}$	
Solid clay brick, EN 771-1	1,00	0,20	0,40	0,83	1,25	1,14	0,39	0,78	0,95	1,43
Solid sand-lime brick, EN 771-2	0,43	0,17	0,34	0,35	0,54	0,71	0,13	0,26	0,59	0,88
Vertically perforated clay brick, EN 771-1 <i>e.g.: Wienerberger Doppio Uni</i>	0,14	0,15	0,30	0,12	0,18	0,21	0,11	0,22	0,18	0,27
Hollow clay brick, EN 771-1 <i>e.g.: Imerys Optibric PV</i>	0,09	0,09	0,18	0,07	0,11	0,14	0,10	0,20	0,12	0,18
Vertically perforated clay brick, EN 771-1 <i>e.g.: Bergmann HLZ 12</i>	0,14	0,10	0,20	0,12	0,18	0,26	0,27	0,54	0,22	0,33
Sand-lime perforated brick, KSL-R 8DF DIN 106 / EN 771-2	0,14	0,13	0,26	0,12	0,18	0,34	0,15	0,30	0,29	0,43

<sup>1)</sup> Information for masonry base material : see Annex C2, Table 9

**G&B Plastic anchor GX-L**

**Displacements in concrete and masonry**

**Annex C3**