

CHEMFIx 100 - Pure Epoxy

Features and Benefits

Version 02/04/2020

- High bond strength with High load resistance
- Used with all grades of threaded rod and rebar in accordance with TR029
- Ideal for deep embedment installations
- Used in non-cracked and cracked concrete
- Used in dry and wet concrete and also in wood
- Used in flooded holes
- Used for overhead applications
- ETA approved for rebar installations under EAD 330087-00-0601 and EN1992-1-1:2004 EC2
- ETA approval for Option 1 and 7 under EAS330499-00-0601
- Zero shrinkage enables large diameter installations
- Independently tested and approved - anchor life 50 years
- ETA approved for dust free drilling (hollow drill bits and vacuum cleaner)
- ETA approved for diamond drilling

Contents

PAGE 1 - Features and Benefits

PAGE 2 - Typical characteristic and design resistance performance with 5.8 grade studding and associated installation data in non-cracked concrete C20/25 without considering concrete cone failure/edge failure or splitting failure

PAGES 3 to 6 Design Resistance used with various stud strengths material and rebar in non-cracked concrete C20/25 without considering concrete cone failure/edge failure or splitting failure bond strengths for hef 4d (minimum embedment) to 20d

PAGE 7,8 - Characteristic and Design load resistances based on characteristic bond strengths for hef 4d (minimum embedment) to 20d

PAGE 9,10- Bond Strength Factors

PAGE 11- Material properties for threaded rods and rebar

PAGE 12- Post Installed Rebar values

PAGE 13- Post Installed Rebar schematics

PAGE 14 - Tension Edge and Spacing reduction factors

PAGE 15 - Curing Time / Temperature Range

PAGE 16 - Installation parameters: drilling hole cleaning and installation

PAGE 17 - Notes

Shelf Life and Storage

This product should be stored between +5°C & +25°C.

The Shelf life of the product is 24 months from the manufacture date.

IMPORTANT The information and data given is based on our own experience, research and testing and is believed to be reliable and accurate.

However, as we cannot know the varied uses to which its products may be applied, or the methods of application used, no warranty as to the fitness or suitability of its products is given or implied. It is the users responsibility to determine suitability of use. For further information please contact Our Technical Department.

CHEMFIX 100 - Pure Epoxy

Product Description

Chemfix 100 is a 2 component high strength pure epoxy chemical anchoring resin system. It is designed for deep embedment and large diameter holes due to its zero shrinkage, and longer working times. For diamond drilled holes, with rebar, and in areas of high chemical exposure eg. Seasalt and swimming pools. Available in Sizes: 400ml Cartridge or 600ml Cartridge.

Specific Benefits

- Long working times
- Very high loads possible
- High chemical resistance
- Fixing studs in wood
- 24 Month shelf life
- Diamond drilled holes
- Zero shrinkage
- European approved
- Fire approved
- Studs and rebar

Approvals

- ETA for Option 1 and 7
- BS6920 for use with potable water **WRAS Approved**
- Tested according to LEED 2009 EQ c4.1, SCAQMD rule 1168 (2005).
- Use with potable water
- A+ Rating VOC content

Typical characteristic and design resistance performance with 5.8 grade studding and associated installation data

Stud Ø (mm)	Characteristic Resistance (kN)		Design Resistance (kN)		Recommended Load (kN)		Characteristic distances (mm)			Min Edge and Spacing (mm)	Nominal Embedment (mm)	Hole Diameter concrete (mm)	Hole Diameter fixture (mm)	Max Torque (Nm)
	Tension	Shear	Tension	Shear	Tension	Shear	Edge	Spacing	Edge					
	N _{rk}	V _{rk}	N _{rd}	V _{rd}	N _{rec}	V _{rec}	C _{cr,N}	S _{cr,N}	C _{cr,V}	C _{min} , S _{min}				
M8	18.18		10.10		7.21							40		
	22.86	9.00	12.70	7.20	9.07	5.14	80	160	80	40	80	10	9	10
	22.86		12.70		9.07							160		
M10	28.26		15.70		11.21							50		
	36.18	15.00	20.10	12.00	14.36	8.57	100	200	90	40	90	12	12	20
	36.18		20.10		14.36							200		
M12	40.68		22.60		16.14							60		
	52.56	21.00	29.20	16.80	20.86	12.00	120	240	110	60	110	14	14	40
	52.56		29.20		20.86							240		
M16	59.76		33.20		23.71							70		
	97.92	39.00	54.40	31.20	38.86	22.29	160	320	125	80	125	18	18	80
	97.92		54.40		38.86							320		
M20	85.50		47.50		33.93							80		
	152.82	61.00	84.90	48.80	60.64	34.86	200	400	180	100	170	22	22	120
	152.82		84.90		60.64							400		
M24	128.16		71.20		50.86							100		
	220.32	88.00	122.40	70.40	87.43	50.29	240	480	220	120	210	28	26	160
	220.32		122.40		87.43							480		
M27	149.22		82.90		59.21							110		
	286.38	115.00	159.10	92.00	113.64	65.71	270	540	240	135	240	30	30	180
	286.38		159.10		109.52							540		
M30	180.90		100.50		71.79							120		
	350.10	142.50	194.50	114.00	138.93	81.43	300	600	280	150	280	35	32	200
	350.10		194.50		138.93							600		
M33	202.14		112.30		80.21							130		
	433.08	173.50	240.60	138.80	171.86	99.14	330	660	310	165	300	37	36	250
	433.08		240.60		171.86							660		
M36	237.60		132.00		94.29							140		
	509.76	212.50	283.20	170.00	202.29	121.43	360	720	330	180	340	40	38	300
	509.76		283.20		202.29							720		

 = steel failure

Table notes : see back page

CHEMFIX 100 - Pure Epoxy

Design Resistance used with various stud strengths, material and rebar.

5.8 Grade Steel Studding

Stud Diameter (mm)	Hole Diameter (mm)	Embedment depth hef (mm)																				steel failure	hef failure (mm)	F _{d,s} design load (kN)			
		40	50	60	70	80	90	100	110	120	130	140	160	200	240	280	320	400	480	540	600				660	720	
8	10	10.1	12.7																						50	12.7	
10	12	12.6	15.7	18.9	20.1																				64	20.1	
12	14		18.9	22.6	26.4	29.2																			78	29.2	
16	18				33.2	38.0	42.7	47.5	52.2	54.4															115	54.4	
20	22					47.5	53.4	59.3	65.3	71.2	77.2	83.1	84.9												143	84.9	
24	28								71.2	78.3	85.5	92.6	99.7	113.9	122.4											172	122.4
27	30									82.9	90.5	98.0	105.6	120.7	150.8	159.1										211	159.1
30	35										100.5	108.9	117.3	134.1	167.6	195										232	194.5
33	38											112.3	121.0	138.2	172.8	207.4	241									278	240.6
36	40												132.0	150.8	188.5	226.2	263.9	283.2								300	283.2
Depth (mm)		40	50	60	70	80	90	100	110	120	130	140	160	200	240	280	320	400	480	540	600	660	720				

8.8 Grade Steel Studding

Stud Diameter (mm)	Hole Diameter (mm)	Embedment depth hef (mm)																				steel failure	hef failure (mm)	F _{d,s} design load (kN)				
		40	50	60	70	80	90	100	110	120	130	140	160	200	240	280	320	400	480	540	600				660	720		
8	10	10.1	12.6	15.1	17.6	19.5																				78	19.5	
10	12	12.6	15.7	18.9	22.0	25.1	28.3	30.9																			98	30.9
12	14		18.9	22.6	26.4	30.2	33.9	37.7	41.5	45.0																119	45.0	
16	18				33.2	38.0	42.7	47.5	52.2	57.0	61.7	66.5	76.0	83.7												176	83.7	
20	22					47.5	53.4	59.3	65.3	71.2	77.2	83.1	95.0	118.7	130.7											220	130.7	
24	28								71.2	78.3	85.5	92.6	99.7	113.9	142.4	170.9	188.3									264	188.3	
27	30									82.9	90.5	98.0	105.6	120.7	150.8	181.0	211.1	241.3	244.8							325	244.8	
30	35										100.5	108.9	117.3	134.1	167.6	201.1	234.6	268.1	299.2							357	299.2	
33	38											112.3	121.0	138.2	172.8	207.4	241.9	276.5	345.6	370.1						428	370.1	
36	40												132.0	150.8	188.5	226.2	263.9	301.6	377.0	435.7						462	435.7	
Depth (mm)		40	50	60	70	80	90	100	110	120	130	140	160	200	240	280	320	400	480	540	600	660	720					

Design Resistance used with various stud strengths, material and rebar.

10.9 Grade Steel Studding

Stud Diameter (mm)	Hole Diameter (mm)	Embedment depth h _{ef} (mm)																				h _{ef} failure (mm)	F _{d,s} design load (kN)		
		40	50	60	70	80	90	100	110	120	130	140	160	200	240	280	320	400	480	540	600			660	720
8	10	10.1	12.6	15.1	17.6	20.1	22.6	25.1	27.2														108	27.2	
10	12	12.6	15.7	18.9	22.0	25.1	28.3	31.4	34.6	37.7	40.8	43.1											137	43.1	
12	14		18.9	22.6	26.4	30.2	33.9	37.7	41.5	45.2	49.0	52.8	60.3	62.6									166	62.6	
16	18				33.2	38.0	42.7	47.5	52.2	57.0	61.7	66.5	76.0	95.0	113.9	116.6							246	116.6	
20	22					47.5	53.4	59.3	65.3	71.2	77.2	83.1	95.0	118.7	142.4	166.2	182.0						307	182.0	
24	28								71.2	78.3	85.5	92.6	99.7	113.9	142.4	170.9	199.4	227.9	262.2				368	262.2	
27	30									82.9	90.5	98.0	105.6	120.7	150.8	181.0	211.1	241.3	301.6	341.0			452	341.0	
30	35										100.5	108.9	117.3	134.1	167.6	201.1	234.6	268.1	335.1	402.2	416.7		497	416.7	
33	38											112.3	121.0	138.2	172.8	207.4	241.9	276.5	345.6	414.7	466.6	515.5	597	515.5	
36	40												132.0	150.8	188.5	226.2	263.9	301.6	377.0	452.4	509.0	565.6	606.9	644	606.9
Depth (mm)		40	50	60	70	80	90	100	110	120	130	140	160	200	240	280	320	400	480	540	600	660	720		

A4-70 Stainless Steel Studding

Stud Diameter (mm)	Hole Diameter (mm)	Embedment depth h _{ef} (mm)																				h _{ef} failure (mm)	F _{d,s} design load (kN)		
		40	50	60	70	80	90	100	110	120	130	140	160	200	240	280	320	400	480	540	600			660	720
8	10	10.1	12.6	13.7																			60	13.7	
10	12	12.6	15.7	18.9	21.7																		69	21.7	
12	14		18.9	22.6	26.4	30.2	31.6																84	31.6	
16	18				33.2	38.0	42.7	47.5	52.2	57.0	58.8												124	58.8	
20	22					47.5	53.4	59.3	65.3	71.2	77.2	83.1	91.7										155	91.7	
24	28								71.2	78.3	85.5	92.6	99.7	113.9	132.1								186	132.1	
27	30									80.2													106	80.2	
30	35										98.1												117	98.1	
33	38											112.3	121										140	121.3	
36	40												132.0	143									152	142.8	
Depth (mm)		40	50	60	70	80	90	100	110	120	130	140	160	200	240	280	320	400	480	540	600	660	720		

*1 = Tensile strength 500N/mm²

Design Resistance used with various stud strengths, material and rebar.

A4-80 Stainless Steel Studding

Stud Diameter (mm)	Hole Diameter (mm)	Embedment depth hef (mm)																				Failure Mode	h _{ef} (mm)	F _{d,s} design load (kN)							
		40	50	60	70	80	90	100	110	120	130	140	160	200	240	280	320	400	480	540	600				660	720					
8	10	10.1	12.6	15.1	15.7																						steel failure	62	15.7		
10	12	12.6	15.7	18.9	22.0	24.8																							79	24.8	
12	14		18.9	22.6	26.4	30.2	33.9	36.1																					96	36.1	
16	18				33.2	38.0	42.7	47.5	52.2	57.0	61.7	66.5	67.2																141	67.2	
20	22					47.5	53.4	59.3	65.3	71.2	77.2	83.1	95.0	104.8															177	104.8	
24	28								71.2	78.3	85.5	92.6	99.7	113.9	132.1														2	186	132.1
27	30									80.2																			1	106	80.2
30	35										98.1																		1	117	98.1
33	38											112.3	121.3																1	140	121.3
36	40													132.0	142.8														1	152	142.8
Depth (mm)		40	50	60	70	80	90	100	110	120	130	140	160	200	240	280	320	400	480	540	600	660	720								

High bond reinforcing bars F_{yk}=500N/mm²

Rebar Diameter (mm)	Hole Diameter (mm)	Embedment depth hef (mm)																				Failure Mode	h _{ef} (mm)	F _{d,s} yield load (kN)							
		40	50	60	70	80	90	100	110	120	130	140	160	200	240	280	320	400	500	560	640				720	800					
8	10	10.7	13.4	16.1	18.8	21.4	21.9																							82	25.2
10	12	12.6	15.7	18.9	22.0	25.1	28.3	31.4	34.1																					109	34.1
12	14		14.7	17.6	20.5	23.5	26.4	29.3	32.3	35.2	38.1	41.1	46.9	49.2																168	49.2
14	16			19.1	22.2	25.4	28.6	31.8	34.9	38.1	41.3	44.5	50.8	63.5	67.0															211	67.0
16	20				25.4	29.0	32.7	36.3	39.9	43.6	47.2	50.8	58.1	72.6	87.1	87.4														241	87.4
20	25					36.3	40.8	45.4	49.9	54.5	59.0	63.5	72.6	90.8	108.9	127.1	136.6													301	136.6
25	30								52.4	57.6	62.8	68.1	73.3	83.8	104.7	125.7	146.6	167.6	209.5	213.5										408	213.5
28	35									59.1	64.5	69.9	75.3	86.0	107.5	129.0	150.5	172.0	215.1	267.8										498	267.8
32	40										72.6	78.2	89.4	111.7	134.1	156.4	178.7	223.4	279.3	312.8	349.7									626	349.7
36	44											88.0	100.5	125.7	150.8	176.0	201.1	251.4	314.2	351.9	402.2	443.5								706	443.5
40	50												111.7	139.6	167.6	195.5	223.4	279.3	349.1	391.0	446.9	502.7	546.3							782	546.3
Depth (mm)		40	50	60	70	80	90	100	110	120	130	140	160	200	240	280	320	400	500	560	640	720	800								

*1 = Tensile strength 500N/mm²

*2 = Tensile strength 700N/mm²

Design Resistance used with various stud strengths, material and rebar.

High bond reinforcing bars $F_{yk}=420N/mm^2$

Rebar Diameter (mm)	Hole Diameter (mm)	Embedment depth h_{ef} (mm)																			h_{ef} failure (mm)	$F_{d,s}$ yield load (kN)								
		40	50	60	70	80	90	100	110	120	130	140	160	200	240	280	320	400	500	560			640	720	800					
8	10	10.7	13.4	16.1	18.4	steel failure																			69	18.4				
10	12	12.6	15.7	18.9	22.0	25.1	28.3	28.7	steel failure																			91	28.7	
12	14			17.6	20.5	23.5	26.4	29.3	32.3	35.2	38.1	41.1	41.3	steel failure										141	41.3					
14	16			19.1	22.2	25.4	28.6	31.8	34.9	38.1	41.3	44.5	50.8	56.2	steel failure								177	56.2						
16	20					25.4	29.0	32.7	36.3	39.9	43.6	47.2	50.8	58.1	72.6	73.4	steel failure						202	73.4						
20	25							36.3	40.8	45.4	49.9	54.5	59.0	63.5	72.6	90.8	108.9	114.8	steel failure					253	114.8					
25	30									52.4	57.6	62.8	68.1	73.3	83.8	104.7	125.7	146.6	167.6	179.3	steel failure				342	179.3				
28	35											59.1	64.5	69.9	75.3	86.0	107.5	129.0	150.5	172.0	215.1	225.0	steel failure			418	225.0			
32	40													72.6	78.2	89.4	111.7	134.1	156.4	178.7	223.4	279.3	293.7	steel failure		526	293.7			
36	44															88.0	100.5	125.7	150.8	176.0	201.1	251.4	314.2	351.9	372.5	steel failure	593	372.5		
40	50																	111.7	139.6	167.6	195.5	223.4	279.3	349.1	391.0	446.9	458.9	steel failure	657	458.9
Depth (mm)		40	50	60	70	80	90	100	110	120	130	140	160	200	240	280	320	400	500	560	640	720	800							

CHEMFIx 100 - Pure Epoxy

Characteristic and Design Load resistances based on characteristic bond strengths for hef 4d (minimum embedment) to 20d

Stud Ø (mm)	Non Cracked Concrete						Cracked Concrete						Nominal Embed-ment (mm)
	Characteristic Resistance (kN)		Design Resistance (kN)		Recommended Load (kN)		Characteristic Resistance (kN)		Design Resistance (kN)		Recommended Load (kN)		
	Tension N _{rk}	Shear V _{rk}	Tension N _{rd}	Shear V _{rd}	Tension N _{rec}	Shear V _{rec}	Tension N _{rk}	Shear V _{rk}	Tension N _{rd}	Shear V _{rd}	Tension N _{rec}	Shear V _{rec}	
M8	18.18		10.10		7.21		Not Applicable	Not Applicable	Not Applicable	Not Applicable	Not Applicable	Not Applicable	40
	36.18	9.00	20.10	7.20	14.36	5.14							80
	72.36		40.20		28.71								160
M10	28.26		15.70		11.21		Not Applicable	Not Applicable	Not Applicable	Not Applicable	Not Applicable	Not Applicable	50
	50.94	15.00	28.30	12.00	20.21	8.57							90
	113.04		62.80		44.86								200
M12	40.68		22.60		16.14		Not Applicable	Not Applicable	Not Applicable	Not Applicable	Not Applicable	Not Applicable	60
	74.70	21.00	41.50	16.80	29.64	12.00							110
	162.90		90.50		64.64								240
M16	59.76		33.20		23.71		Not Applicable	Not Applicable	Not Applicable	Not Applicable	Not Applicable	Not Applicable	70
	106.74	39.00	59.30	31.20	42.36	22.29							125
	273.42		151.90		108.50								320
M20	56.05		47.50		33.93		Not Applicable	Not Applicable	Not Applicable	Not Applicable	Not Applicable	Not Applicable	80
	181.62	61.00	100.90	48.80	72.07	34.86							170
	427.32		237.40		169.57								400
M24	128.16		71.20		50.86		Not Applicable	Not Applicable	Not Applicable	Not Applicable	Not Applicable	Not Applicable	100
	269.28	88.00	149.60	70.40	106.86	50.29							210
	613.80		341.00		243.57								480
M27	149.22		82.90		59.21		Not Applicable	Not Applicable	Not Applicable	Not Applicable	Not Applicable	Not Applicable	110
	325.80	115.00	181.00	92.00	129.29	65.71							240
	732.96		407.20		290.86								540
M30	180.90		100.50		71.79		Not Applicable	Not Applicable	Not Applicable	Not Applicable	Not Applicable	Not Applicable	120
	422.28	142.50	234.60	114.00	167.57	81.43							280
	904.86		502.70		359.07								600
M33	202.14		112.30		80.21		Not Applicable	Not Applicable	Not Applicable	Not Applicable	Not Applicable	Not Applicable	130
	466.56	173.50	259.20	138.80	185.14	99.14							300
	1026.54		570.30		407.36								660
M36	254.52		141.40		101.00		Not Applicable	Not Applicable	Not Applicable	Not Applicable	Not Applicable	Not Applicable	150
	576.90	212.50	320.50	170.00	228.93	121.43							340
	1221.66		678.70		484.79								720

Table notes : see back page

CHEMFIx 100 - Pure Epoxy

Characteristic and Design Load resistances for **REBAR** based on characteristic bond strengths for *hef 4d* (min embedment) to *20d*

Rebar fyk=500 N/mm ²	Non Cracked Concrete						Cracked Concrete						Nominal Embed-ment (mm)																		
	Characteristic Resistance (kN)		Design Resistance (kN)		Recommended Load (kN)		Characteristic Resistance (kN)		Design Resistance (kN)		Recommended Load (kN)																				
	Tension	Shear	Tension	Shear	Tension	Shear	Tension	Shear	Tension	Shear	Tension	Shear																			
Ø (mm)	N _{rk}	V _{rk}	N _{rd}	V _{rd}	N _{rec}	V _{rec}	N _{rk}	V _{rk}	N _{rd}	V _{rd}	N _{rec}	V _{rec}																			
8	19.26	9.00	10.70	7.20	7.64	5.14	Not Applicable	Not Applicable	Not Applicable	Not Applicable	Not Applicable	Not Applicable	40																		
	38.52		21.40		15.29								80																		
	77.22		42.90		30.64								160																		
10	22.68	15.00	12.60	12.00	9.00	8.57							Not Applicable	Not Applicable	Not Applicable	Not Applicable	Not Applicable	Not Applicable	40												
	50.94		28.30		20.21														90												
	113.04		62.80		44.86														200												
12	26.46	21.00	14.70	16.80	10.50	12.00													Not Applicable	Not Applicable	Not Applicable	Not Applicable	Not Applicable	Not Applicable	50						
	58.14		32.30		23.07																				110						
	126.72		70.40		50.29																				240						
14	34.38	39.00	19.10	31.20	13.64	22.29																			Not Applicable	Not Applicable	Not Applicable	Not Applicable	Not Applicable	Not Applicable	60
	68.58		38.10		27.21																										120
	160.20		89.00		63.57																										280
16	45.72	39.00	25.40	31.20	18.14	22.29	Not Applicable	Not Applicable	Not Applicable	Not Applicable	Not Applicable	Not Applicable																			70
	81.72		45.40		32.43																										125
	209.16		116.20		83.00																										320
20	42.83	61.00	36.30	48.80	25.93	34.86							Not Applicable	Not Applicable	Not Applicable	Not Applicable	Not Applicable	Not Applicable													80
	138.96		77.20		55.14																										170
	326.70		181.50		129.64																										400
25	94.32	88.00	52.40	70.40	37.43	50.29													Not Applicable	Not Applicable	Not Applicable	Not Applicable	Not Applicable	Not Applicable							100
	198.00		110.00		78.57																										210
	471.24		261.80		187.00																										500
28	106.38	115.00	59.10	92.00	42.21	65.71																			Not Applicable	Not Applicable	Not Applicable	Not Applicable	Not Applicable	Not Applicable	110
	232.20		129.00		92.14																										240
	541.98		301.10		215.07																										560
32	130.68	142.50	72.60	114.00	51.86	81.43	Not Applicable	Not Applicable	Not Applicable	Not Applicable	Not Applicable	Not Applicable																			130
	281.52		156.40		111.71																										280
	643.50		357.50		255.36																										640
36	158.40	173.50	88.00	138.80	62.86	99.14							Not Applicable	Not Applicable	Not Applicable	Not Applicable	Not Applicable	Not Applicable													140
	361.98		201.10		143.64																										320
	814.32		452.40		323.14																										720
40	201.06	212.50	111.70	170.00	79.79	121.43													Not Applicable	Not Applicable	Not Applicable	Not Applicable	Not Applicable	Not Applicable							160
	427.32		237.40		169.57																										340
	1005.48		558.60		399.00																										800

Table notes : see back page

CHEMFIX 100 - Pure Epoxy

Bond Strength Factors for threaded bars

Influence of concrete strength on combined pull out and concrete cone resistance

Concrete Strength N/mm ² (Mpa)	C15/20	C20/25	C25/30	C30/37	C35/45	C40/50	C45/55	C50/60
f_c =	0.98	1.00	1.05	1.10	1.15	1.18	1.20	1.23

Influence of environmental conditions in non cracked concrete

		M8	M10	M12	M16	M20	M24	M27	M30	M33	M36
Temp I 40°C / 24°C	Dry and Wet	1.00	1.00	1.00	1.00	1.00	1.00	1.00	1.00	1.00	1.00
	Flooded	0.77	0.77	0.77	0.77	0.77	0.77	0.77	0.77	0.77	0.77
Temp II 60°C / 40°C	Dry and Wet	0.89	0.89	0.89	0.89	0.89	0.89	0.89	0.89	0.89	0.89
	Flooded	0.69	0.69	0.69	0.69	0.69	0.69	0.69	0.69	0.69	0.69

Influence of environmental conditions in cracked concrete

		M8	M10	M12	M16	M20	M24	M27	M30	M33	M36
Temp I 40°C / 24°C	Dry and Wet	n/a	n/a	0.39	0.44	0.47	0.47	0.50	0.50	0.53	0.53
	Flooded	n/a	n/a	0.30	0.34	0.36	0.36	0.38	0.38	0.41	0.41
Temp II 60°C / 40°C	Dry and Wet	n/a	n/a	0.35	0.40	0.43	0.43	0.45	0.45	0.48	0.48
	Flooded	n/a	n/a	0.27	0.31	0.33	0.33	0.35	0.35	0.37	0.37

Table notes : see back page

CHEMFIx 100 - Pure Epoxy

Bond Strength Factors for REBAR

Influence of concrete strength on combined pull out and concrete cone resistance

Concrete Strength N/mm ² (Mpa)	C15/20	C20/25	C25/30	C30/37	C35/45	C40/50	C45/55	C50/60
fc non-cracked =	0.98	1.00	1.04	1.08	1.11	1.15	1.18	1.21
fc cracked =	0.98	1.00	1.08	1.17	1.24	1.32	1.37	1.42

Influence of environmental conditions in non cracked concrete

		φ8	φ10	φ12	φ14	φ16	φ20	φ25	φ28	φ32	φ36	φ40
Temp I 40°C / 24°C	Dry and Wet	1.00	1.00	1.00	1.00	1.00	1.00	1.00	1.00	1.00	1.00	1.00
	Flooded	0.63	0.63	0.77	0.77	0.77	0.77	0.77	0.77	0.77	0.77	0.77
Temp II 60°C / 40°C	Dry and Wet	0.89	0.89	0.89	0.89	0.89	0.89	0.89	0.89	0.89	0.89	0.89
	Flooded	0.56	0.56	0.69	0.69	0.69	0.69	0.69	0.69	0.69	0.69	0.69

Influence of environmental conditions in cracked concrete

		φ8	φ10	φ12	φ14	φ16	φ20	φ25	φ28	φ32	φ36	φ40
Temp I 40°C / 24°C	Dry and Wet	n/a	n/a	0.49	0.50	0.53	0.54	0.58	0.63	0.70	0.70	0.70
	Flooded	n/a	n/a	0.38	0.38	0.41	0.42	0.45	0.48	0.54	0.54	0.54
Temp II 60°C / 40°C	Dry and Wet	n/a	n/a	0.45	0.45	0.48	0.49	0.53	0.57	0.64	0.64	0.64
	Flooded	n/a	n/a	0.34	0.35	0.37	0.38	0.41	0.44	0.49	0.49	0.49

Table notes : see back page

CHEMFIX 100 - Pure Epoxy

Material Properties for grades of other threaded rod and rebar

Stud Diameter (mm)	Stud Grade 8.8		Stud Grade 10.9		Stud Grade A4-70		Stud Grade A4-80	
	$N_{rk,s}$ (kN)	$N_{rd,s}$ (kN)	$N_{rk,s}$ (kN)	$N_{rd,s}$ (kN)	$N_{rk,s}$ (kN)	$N_{rd,s}$ (kN)	$N_{rk,s}$ (kN)	$N_{rd,s}$ (kN)
M8	29.2	19.5	38.1	27.2	25.6	13.7	29.2	15.6
M10	46.4	30.9	60.3	43.1	40.6	21.7	46.4	24.8
M12	67.4	44.9	87.7	62.6	59.0	31.6	67.4	36.0
M16	125.6	83.7	163.0	116.4	109.9	58.8	125.7	67.2
M20	196.1	130.7	255.0	182.1	171.5	91.7	196.0	104.8
M24	282.5	188.3	367.0	262.1	247.1	132.1	293.0	132.1
M27	367.0	244.7	477.4	341.0	229.4	80.2	229.4	80.2
M30	448.8	299.2	583.0	416.4	280.6	98.1	280.6	98.1
M33	555.2	370.1	721.8	515.5	347.0	121.3	347.0	121.3
M36	653.6	435.7	849.7	606.9	408.4	142.8	408.4	142.8

Stud Diameter (mm)	Stud Grade 8.8		Stud Grade 10.9		Stud Grade A4-70		Stud Grade A4-80	
	$V_{rk,s}$ (kN)	$V_{rd,s}$ (kN)	$V_{rk,s}$ (kN)	$V_{rd,s}$ (kN)	$V_{rk,s}$ (kN)	$V_{rd,s}$ (kN)	$V_{rk,s}$ (kN)	$V_{rd,s}$ (kN)
M8	14.6	11.7	19.0	12.7	12.8	8.2	14.6	9.4
M10	23.2	18.6	30.2	20.1	20.3	13.0	23.2	14.9
M12	33.7	27.0	43.8	29.2	29.5	18.9	33.7	21.6
M16	62.8	50.2	81.6	54.4	55.0	35.2	62.8	40.3
M20	98.0	78.4	127.4	84.9	85.8	55.0	98.0	62.8
M24	141.2	113.0	183.6	122.4	123.6	79.2	141.2	90.5
M27	183.5	146.8	238.7	191.0	114.7	48.4	114.7	48.4
M30	224.4	179.5	291.5	194.3	140.3	89.9	140.3	89.9
M33	277.6	222.1	360.9	288.7	173.5	111.2	173.5	111.2
M36	326.8	261.4	424.8	283.2	204.2	130.9	204.2	130.9

Rebar Diameter (mm)	Rebar BSt 500 to DIN 488		Rebar BSt 500 to DIN 488	
	$N_{rk,s}$ (kN)	$N_{rd,s}$ (kN)	$V_{rk,s}$ (kN)	$V_{rd,s}$ (kN)
8	28.0	20.0	14.0	9.3
10	43.0	30.7	21.5	14.3
12	62.0	44.3	31.0	20.7
14	85.0	60.7	42.5	28.3
16	111.0	79.3	55.5	37.0
18	140.0	100.0	70.0	46.7
20	173.0	123.6	86.5	57.7
22	209.0	149.3	104.5	69.7
25	270.0	192.9	135.0	90.0
28	339.0	242.1	169.0	112.7
32	442	315.7	221	147.3
36	563.2	443.5	281.6	187.7
40	693.8	546.3	346.9	231.3

Table notes : see back page

Post installed rebar connections

Minimum anchorage length ¹⁾ and lap splice length for C20/25 and maximum installation length (l_{max})

Rebar		$l_{b,min}$ (mm)	$l_{o,min}$ (mm)	$l_{max,min}$ (mm)
$\varnothing d_s$	$f_{y,k}$ (N/mm ²)			
8mm	500	113	200	1000
10mm	500	142	200	1000
12mm	500	170	200	1200
14mm	500	198	210	1400
16mm	500	227	240	1600
20mm	500	284	300	2000
22mm	500	312	330	2000
24mm	500	340	360	2000
25mm	500	354	375	2000
28mm	500	397	420	2000
32mm	500	454	480	2000
34mm	500	482	510	2000
36mm	500	534	540	2000
40mm	500	621	600	2000

N/mm² = MPa

1) According to EN 1992-1-1:2004 $l_{b,min}$ (8.6) and $l_{o,min}$ (8.11) for good bond conditions and $a_g = 1,0$
with maximum yield stress for rebar B500 B and $\gamma_M = 1,15$

Design values of the ultimate bond resistance f_{bd} ¹⁾ in N/mm² for all drilling methods for good conditions

Rebar \varnothing	Concrete Class								
	C12/15	C16/20	C20/25	C25/30	C30/37	C35/45	C40/50	C45/60	C50/60
8mm to 25mm	1.6	2	2.3	2.7	3	3.4	3.7	4	4.3
28mm to 36mm	1.6	2	2.3	2.7	3	3.4	3.7	3.7	4
40mm	1.6	2	2.3	2.7	3	3	3	3.4	3.4

1) Tabulated values for f_{bd} are valid for good bond condition according to EN1992-1-1:2004. For all other bond conditions multiply the values for f_{bd} by 0.7.

Post installed rebar schematics

Application examples of post-installed rebar

Figure 1: Overlap joints in slabs and beams.

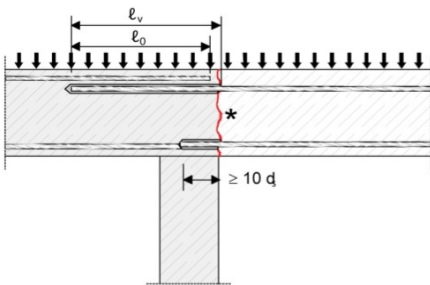

Figure 2: Overlap joint in foundation of a column or wall where the rebars are stressed in tension.

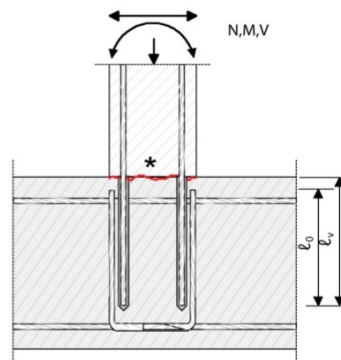

Figure 3: End anchoring of slabs or beams, designed as simply supported.

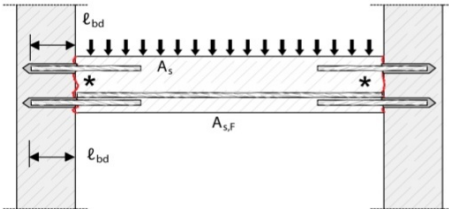

Figure 4: Rebar connection of components stressed primarily in compression. The rebar are stressed in compression.

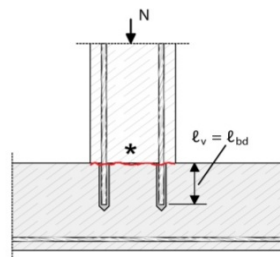
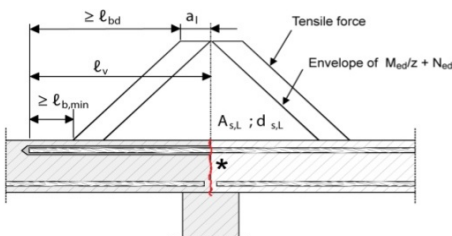

Figure 5: Anchoring of reinforcement to cover the line of acting tensile force.



Note to figure 1 to 5 :

In the figures no transverse reinforcement is plotted, the transverse reinforcement as required by EC 2 shall be present. The shear transfer between old and new concrete shall be designed according to EC2. Description of the bonded-in rebars and overlap joints see Annex 4 and 5.

*** Roughened joint**

CHEMFIx 100 - Pure Epoxy

Effect of Anchor Spacing - Tension

Anchor Spacing (mm)	Stud / Rebar Diameter										
	8	10	12	16	20	24	27	30	33	36	40
40	0.64										
50	0.67	0.63									
60	0.70	0.65	0.63								
70	0.73	0.67	0.64								
80	0.76	0.69	0.66	0.63							
90	0.79	0.72	0.68	0.64							
100	0.82	0.74	0.70	0.65	0.63						
120	0.87	0.79	0.74	0.68	0.65	0.63	0.63				
150	0.96	0.86	0.80	0.73	0.68	0.65	0.64	0.63			
160	1.00	0.88	0.82	0.74	0.70	0.66	0.65	0.63	0.63	0.63	0.63
175		0.92	0.85	0.76	0.71	0.67	0.66	0.64	0.63	0.63	0.63
200		1.00	0.90	0.80	0.74	0.69	0.69	0.66	0.65	0.65	0.65
225			0.95	0.84	0.77	0.72	0.71	0.68	0.67	0.67	0.66
240			1.00	0.86	0.79	0.73	0.72	0.69	0.68	0.68	0.67
250				0.87	0.80	0.74	0.73	0.70	0.69	0.68	0.68
275				0.91	0.83	0.76	0.75	0.72	0.71	0.70	0.69
280				0.92	0.84	0.77	0.76	0.73	0.71	0.70	0.69
300				0.95	0.86	0.79	0.78	0.74	0.73	0.72	0.71
320				1.00	0.88	0.81	0.80	0.76	0.74	0.73	0.72
350					0.92	0.83	0.82	0.78	0.77	0.75	0.73
400					1.00	0.88	0.87	0.82	0.80	0.78	0.76
440						0.92	0.91	0.85	0.83	0.81	0.79
480						1.00	0.94	0.88	0.86	0.84	0.81
540							1.00	0.93	0.91	0.88	0.84
600								1.00	0.96	0.92	0.88
660									1.00	0.96	0.91
720										1.00	0.95
800											1.00

Effect of Edge Distance - Tension

Edge Distance (mm)	Stud / Rebar Diameter										
	8	10	12	16	20	24	27	30	33	36	40
40	0.64										
50	0.73	0.63									
60	0.82	0.70	0.63								
70	0.90	0.77	0.68								
80	1.00	0.84	0.74	0.63							
90		0.91	0.80	0.67							
100		1.00	0.86	0.71	0.63						
110			0.92	0.76	0.66						
120			1.00	0.80	0.70	0.64					
140				0.89	0.77	0.67	0.63	0.63			
160				1.00	0.84	0.72	0.70	0.65	0.63	0.67	
180					0.91	0.78	0.75	0.70	0.66	0.71	0.68
200					1.00	0.84	0.81	0.76	0.71	0.74	0.71
220						0.89	0.86	0.81	0.75	0.78	0.75
240						1.00	0.92	0.86	0.80	0.82	0.78
270							1.00	0.94	0.87	0.87	0.83
300								1.00	0.94	0.93	0.88
330									1.00	0.98	0.93
360										1.00	0.98
400											1.00

Effect of Edge Distance - Shear

Edge Distance (mm)	Stud / Rebar Diameter										
	8	10	12	16	20	24	27	30	33	36	40
40	0.25										
50	0.44	0.30									
60	0.63	0.48	0.30								
70	0.81	0.65	0.44								
80	1.00	0.83	0.58	0.40							
90		1.00	0.72	0.53							
100			0.86	0.67	0.35						
110			1.00	0.80	0.44						
125				1.00	0.58	0.35					
140					0.72	0.46	0.35	0.30			
160					0.91	0.62	0.51	0.35	0.32	0.33	
180					1.00	0.77	0.63	0.46	0.37	0.43	
200						0.92	0.75	0.57	0.46	0.50	0.32
220						1.00	0.88	0.68	0.56	0.56	0.53
240							1.00	0.78	0.65	0.63	0.59
280								1.00	0.84	0.77	0.72
310									1.00	1.00	0.82
330										1.00	0.89
400											1.00

CHEMFIx 100 - Pure Epoxy

Minimum Curing Time

Concrete Temperature	Gel - Working Time	Minimum curing time in dry concrete	Minimum curing time in wet concrete
5°C	70 min	40 h	x 2
10°C	32 min	30 h	x 2
15°C	28 min	24 h	x 2
25°C	22 min	11 h	x 2
30°C	20 min	9 h	x 2
40°C	18 min	8 h	x 2

- All specifications based on supplied mixer

Temperature Ranges

Temperature Range	Concrete Service Temperature	Maximum Long Term Concrete Temp	Maximum Short Term Concrete Temp
Range I	-40°C to +40°C	+24°C	+40°C
Range II	-40°C to +60°C	+40°C	+60°C
Range III for post installed rebar	-40°C to +80°C	+50°C	+80°C

Service temperature range: Range of ambient temperatures after installation and during the lifetime of the anchor.

Short term temperature: Temperatures within the service temperature range which vary over short intervals, e.g. day/night cycles and freeze/thaw cycles.

Long term temperature: Temperature, within the service temperature range, which will be approximately constant over significant periods of time.

Long term temperatures will include constant or near constant temperatures, such as those experienced in cold stores or next to heating installations.

Physical Properties

	N/mm ² (MPa)		Test Method
	24 hours curing	72 hours curing	
Tensile Strength	21.5	21.5	ASTM D638
Compressive Strength	95	100.9	EN 196 Part 1
Flexural Strength	34	46	EN 196 Part 1
Flexural Modulus	2520.3	2985.2	ASTM D790
E Modulus	5997	12024.3	EN 196 Part 1
Density	1.45		
VOC Content	A+ Rating		

CHEMFIX 100 - Pure Epoxy

Installation parameters: drilling hole cleaning and installation

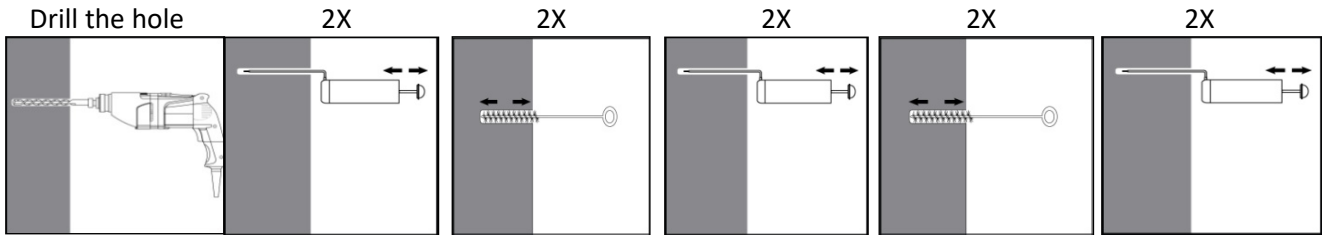

Drill hole in the substrate to the required embedment depth using the appropriately sized carbide drill bit. Bore hole cleaning Just before setting an anchor, the bore hole must be free of dust and debris. The manual pump shall be used for blowing out bore holes up to diameters $d_o \leq 24\text{mm}$ and embedment depths up to $h_{ef} \leq 10d$. Blow out at least 2 times from the back of the bore hole, using an extension if needed. Brush 2 times with the specified brush size by inserting the steel brush to the back of the hole (if needed with an extension) in a twisting motion and removing it. Blow out again with manual pump at least 2 times. Brush 2 times with the specified brush size by inserting the steel brush to the back of the hole. Blow out again with manual pump at least 2 times.

Compressed air cleaning (CAC) for all bore hole diameters do and all bore hole depths

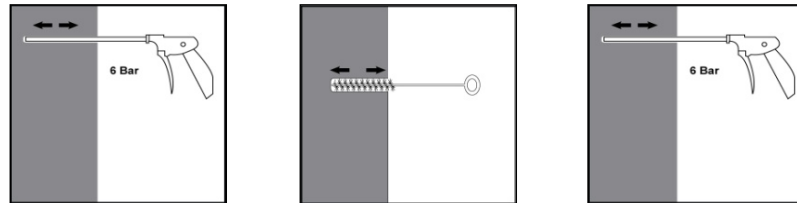

Blow 2 times from the back of the hole (if needed with a nozzle extension) over the whole length with oil-free compressed air (min. 6 bar at $6\text{ m}^3/\text{h}$). Brush 2 times with the specified brush size (see Table 6) by inserting the steel brush to the back of the hole (if needed with an extension) in a twisting motion and removing it.
X 2 Blow out again with compressed air at least 2 times.

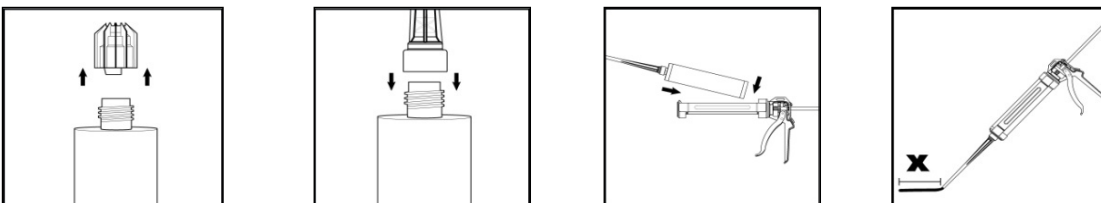

Remove the threaded cap from the cartridge. Tightly attach the mixing nozzle. Do not modify the mixer in any way. Made sure the mixing element is inside the mixer. Use only the supplied mixer. Insert the cartridge into the dispenser gun. Discard the initial trigger pulls of adhesive. Discard the first 12ml of resin. Please note that after every subsequent mixer change, an initial 12ml of resin should be extruded to waste to continue with even mixing.

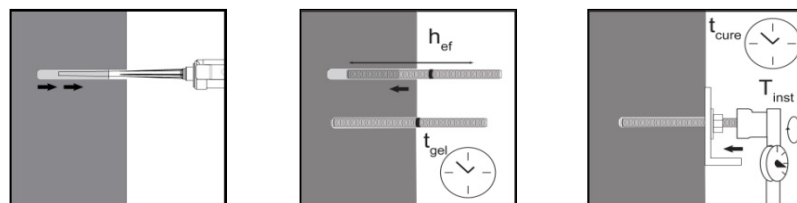

Inject the adhesive starting at the back of the hole, slowly withdrawing the mixer with each trigger pull. Fill holes approximately 2/3 full, to ensure that the annular gap between the anchor and the concrete is completely filled with adhesive along the embedment depth. Before use, verify that the threaded rod is dry and free of contaminants. Install the threaded rod to the required embedment depth during the open gel time t_{gel} has elapsed. The working time t_{gel} is given in Table 7. The anchor can be loaded after the required curing time t_{cure} (see page 12). The applied torque shall not exceed the values T_{max} given..

CHEMFIX 100 - Pure Epoxy

Notes

PAGE 2 :

Typical characteristic and design resistance performance with 5.8 grade studding and associated installation data

All data is based on correct installation - see instructions

No influence of edge and spacing

Minimum base material thickness hef +30mm >100mm for M8 to M12 and for M16 to M30 hef +2 d

he_f range minimum or 4d whichever is greatest to 20d

Concrete strength C20/25 - f_c cube = 25N/mm² (25MPa)

5.8 grade stud

Temperature range I maximum long term / short term temperature +24/40°C

No influence of concrete cone failure or splitting failure

Design Resistance with various stud strengths, material and rebar.

PAGE 3-6 :

All data is based on correct installation - see instructions

No influence of edge and spacing, No influence of concrete cone failure or splitting failure

Minimum base material thickness hef +30mm >100mm for M8 to M12 and for M16 to M30 hef +2 d

he_f range minimum or 4d whichever is greatest to 20d

Concrete strength C20/25 - f_c cube = 25N/mm² (25MPa)

Temperature range I maximum long term / short term temperature +24/40°C

Note 1 for stainless steel tensile strength is 500N/mm² (500MPa)

Note 2 for stainless steel tensile strength is 700N/mm² (500MPa)

PAGE 7 and 8 :

Characteristic and Design Load resistances based on characteristic bond strengths for hef 4d (minimum embedment) to 20d

All data is based on correct installation - see instructions, No influence of edge and spacing, No concrete cone failure or steel failure accounted

Minimum base material thickness hef +30mm >100mm for M8 to M12 and for M16 to M30 hef +2 d

he_f range minimum or 4d whichever is greatest to 20d

Concrete strength C20/25 - f_c cube = 25N/mm² (25MPa), Temperature range I, maximum long term / short term temperature +24/40oC

PAGE 9,10 :

Bond Strength Factors

Select concrete strength and environmental condition and apply to bond strength table on pages 2 to 6

PAGE 11 :

Material Properties for grades of other threaded rod and rebar

All grades shown for information

M30 studding is 8.8 grade instead of 5.8 grade

M30 for A4-70 tensile strength of 500N/mm², (500MPa) instead of 700N/mm² (700MPa)

Safety Factors

For 8.8 grade stud - Tension 1.5 Shear 1.25 / For 10.9 grade stud - Tension 1.4 Shear 1.5

For A4-70 and A4-80 Tension 1.87 Shear 1.56 / For rebar - Tension 1.4 Shear 1.5

Partial Safety Factors Pages 2,3,4,5,6,7,8:

1.8 for all size diameter rebar and studs