



ETA-Danmark A/S
Göteborg Plads 1
DK-21590 Nordhavn
Tel. +45 72 24 59 00
Fax +45 72 24 59 04
Internet www.etadanmark.dk

Authorised and notified according
to Article 29 of the Regulation (EU)
No 305/2011 of the European
Parliament and of the Council of 9
March 2011

MEMBER OF EOTA



European Technical Assessment ETA-18/1157 of 2020/10/30

I General Part

Technical Assessment Body issuing the ETA and designated according to Article 29 of the Regulation (EU) No 305/2011: ETA-Danmark A/S

Trade name of the construction product:

Chemfix 100 and Chemfix 600 bonded anchor for post-installed rebar connections

Product family to which the above construction product belongs:

Post-installed rebar connections with Chemfix 100 injection mortar

Manufacturer:

Chemfix Products Ltd
Mill Street East
Dewsbury
West Yorkshire
WF12 9BQ, UK
Tel. +44 (0) 1924 453886
Fax +44 (0) 1924 431658
Internet www.chemfix.co.uk

Manufacturing plant:

Chemfix Products Ltd
Mill Street East
Dewsbury
West Yorkshire
WF12 9BQ, UK

This European Technical Assessment contains:

18 pages including 13 annexes which form an integral part of the document

This European Technical Assessment is issued in accordance with Regulation (EU) No 305/2011, on the basis of:

EAD 330087-00-0601, Systems for post-installed rebar connections with mortar

This version replaces:

The ETA with the same number issued on 2020-07-09

Translations of this European Technical Assessment in other languages shall fully correspond to the original issued document and should be identified as such.

Communication of this European Technical Assessment, including transmission by electronic means, shall be in full (except the confidential Annexes referred to above). However, partial reproduction may be made, with the written consent of the issuing Technical Assessment Body. Any partial reproduction has to be identified as such.

II SPECIFIC PART OF THE EUROPEAN TECHNICAL ASSESSMENT

1 Technical description of product and intended use

Technical description of the product

The subject of this assessment are the post-installed connections, by anchoring or overlap connection joint consisting of steel reinforcing bars (rebars) in existing structures made of normal weight concrete, using injection mortar Chemfix 100 and Chemfix 600 in accordance with the regulations for reinforced concrete construction. The designation Chemfix 100 and Chemfix 600 relates to the cartridge size only. The design of the post-installed rebar connections shall be done in accordance with EN 1992-1-1 (Eurocode 2).

Reinforcing bars with diameters from 8 to 40 mm and Chemfix 100 injection mortar are used for the post-installed rebar connections. The steel element is placed into a drilled hole filled with a mortar and is anchored by the bond between embedded element, injection mortar and concrete.

The characteristic material values, dimensions and tolerances of the anchors not indicated in Annexes shall correspond to the respective values laid down in the technical documentation¹ of this European Technical Assessment.

The product description is given in Annex A.

2 Specification of the intended use in accordance with the applicable EAD

The performances given in Section 3 are only valid if the rebar connection is used in compliance with the specifications and conditions given in Annex B

The provisions made in this European Technical Assessment are based on an assumed intended working life of the anchor of 50 years.

The indications given on the working life cannot be interpreted as a guarantee given by the producer or Assessment Body, but are to be regarded only as a means for choosing the right products in relation to the expected economically reasonable working life of the works.

¹ The technical documentation of this European Technical Assessment is deposited at ETA-Danmark and, as far as relevant for the tasks of the Notified bodies involved in the attestation of conformity procedure, is handed over to the notified bodies.

3 Performance of the product and references to the methods used for its assessment

3.1 Characteristics of product

Mechanical resistance and stability (BWR1):

The essential characteristics are detailed in the Annex C.

Safety in case of fire (BWR2):

Reaction to fire: Rebar connections satisfy requirements for Class A1.

Resistance to fire: See annex C

Hygiene, health and the environment (BWR3):

No performance assessed.

Safety in use (BWR4):

For basic requirement Safety in use the same criteria are valid for Basic Requirement Mechanical resistance and stability (BWR1).

Sustainable use of natural resources (BWR7)

No performance determined

Other Basic Requirements are not relevant.

3.2 Methods of assessment

The assessment of fitness of the anchor for the intended use in relation to the requirements for mechanical resistance and stability and safety in use in the sense of the Basic Requirements 1 and 4 has been made in accordance with the EAD 330087-00-06.01, Systems for post-installed rebar connections with mortar.

4 Assessment and verification of constancy of performance (AVCP)

4.1 AVCP system

According to the decision 96/582/EC of the European Commission, the system(s) of assessment and verification of constancy of performance (see Annex V to Regulation (EU) No 305/2011) is 1.

5 Technical details necessary for the implementation of the AVCP system, as foreseen in the applicable EAD

Technical details necessary for the implementation of the AVCP system are laid down in the control plan deposited at ETA-Danmark prior to CE marking

Issued in Copenhagen on 2020-10-30 by

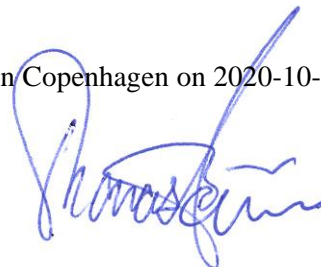

Thomas Bruun
Managing Director, ETA-Danmark

Installation post installed rebar

Figure A1: Overlapping joint for rebar connections of slabs and beams

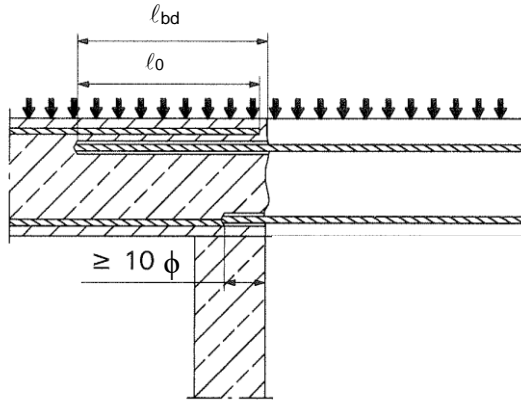

Figure A3: End anchoring of slabs or beams (e.g. designed as simply supported)

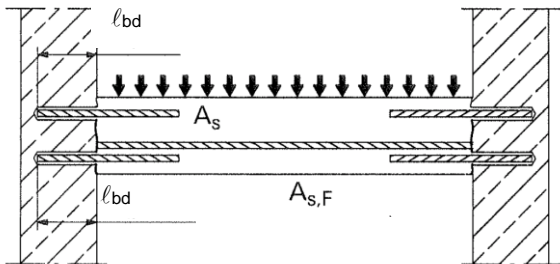

Figure A5: Anchoring of reinforcement to cover the line of acting tensile force

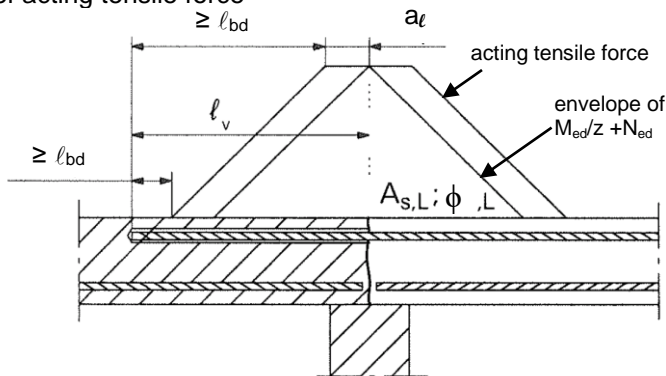

Figure A2: Overlapping joint at a foundation of a wall or column where the rebars are stressed in tension

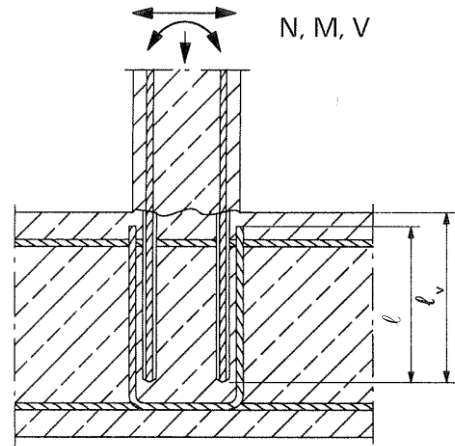
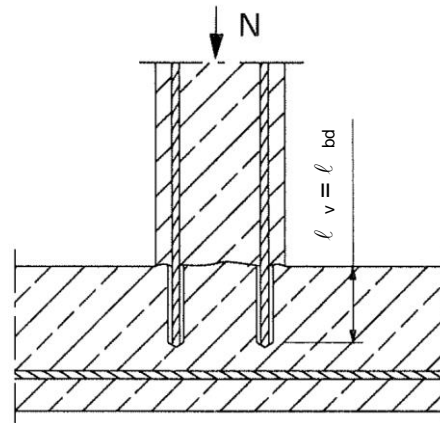

Figure A4: Rebar connection for components stressed primarily in compression. The rebars are stressed in compression



Note to Figure A1 to A5:

In the Figures no transverse reinforcement is plotted, the transverse reinforcement shall comply with EN 1992-1-1:2004+AC:2010.

Preparing of joints according to Annex B 2

<p>Chemfix 100 and Chemfix 600 Injection System for rebar connection</p>	<p>Annex A1</p>
<p>Product description Installed condition and examples of use for rebars</p>	

Chemfix 100 Injection System

Side by Side Cartridge 1:1 ratio
400ml / 600ml / 1500 ml

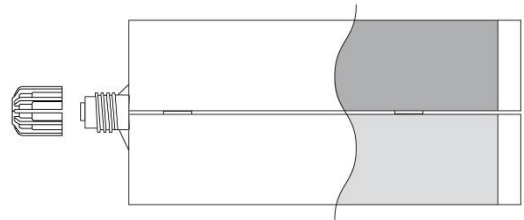

Chemfix 600 Injection System

Side by Side Cartridge 3:1 ratio
385ml / 585ml / 1400ml

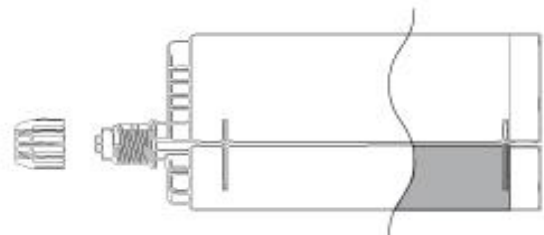

Chemfix 100 and Chemfix 600 Injection System Cartridge

250ml / 280ml / 300ml



Cartridge Print: Chemfix 100 (for 1:1 ratio) or Chemfix 600 (for 3:1 ratio)
Including - Installation procedure, Production Batch code, Expiry Date,
Storage conditions, Health & Safety warning, Gel & Cure time according to
temperatures.

Chemfix 100 and Chemfix 600 Injection System for rebar connection

Product description
Injection mortar – cartridge type and sizes

Annex A2

Static Mixer

Mixer

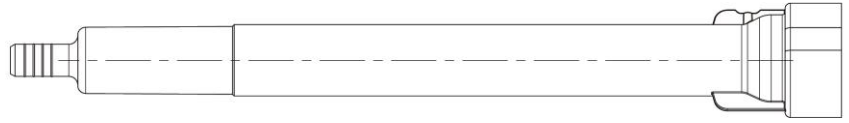

Epoxy Mixer

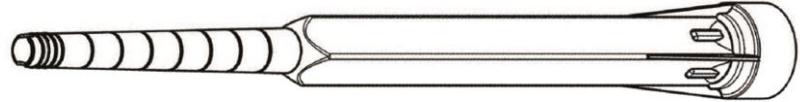

Mixer Extension

Mixer Extension Short



Mixer Extension Long



Reinforcing bar (rebar): ø8, ø10, ø12, ø14, ø16, ø18, ø20, ø22, ø24, ø25, ø28, ø32, ø36, ø40



- Minimum value of related rip area $f_{R,min}$ according to EN 1992-1-1:2004+AC:2010
- Rib height of the bar shall be in the range $0,05\phi \leq h \leq 0,07\phi$
(ϕ : Nominal diameter of the bar; h: Rip height of the bar)

Table A1: Materials

Designation	Material
Rebar EN 1992-1-1:2004+AC:2010, Annex C	Bars and de-coiled rods class B or C f_{yk} and k according to NDP or NCL of EN 1992-1-1/NA:2013 $f_{uk} = f_{tk} = k \cdot f_{yk}$

Chemfix 100 and Chemfix 600 Injection System for rebar connection

Annex A3

Product description
Mixer and Specifications Rebar

Specifications of intended use

Anchorage subject to:

- Static and quasi-static loads.
- Fire exposure

Base materials:

- Reinforced or unreinforced normal weight concrete according to EN 206-1:2000.
- Strength classes C12/15 to C50/60 according to EN 206-1:2000.
- Maximum chloride concrete of 0,40% (CL 0.40) related to the cement content according to EN 206-1:2000.
- Non-carbonated concrete.

Note: In case of a carbonated surface of the existing concrete structure the carbonated layer shall be removed in the area of the post-installed rebar connection with a diameter of $\phi + 60$ mm prior to the installation of the new rebar.

The depth of concrete to be removed shall correspond to at least the minimum concrete cover in accordance with EN 1992-1-1:2004+AC:2010.

The foregoing may be neglected if building components are new and not carbonated and if building components are in dry conditions.

Temperature Range:

- - 40°C to +80°C (max. short term temperature +80°C and max long term temperature +50°C).

Design:

- Anchorages are designed under the responsibility of an engineer experienced in anchorages and concrete work.
- Verifiable calculation notes and drawings are prepared taking account of the forces to be transmitted.
- Design according to EN 1992-1-1:2004+AC: 2010 and Annex B 2.
- The actual position of the reinforcement in the existing structure shall be determined on the basis of the construction documentation and taken into account when designing.
- Anchorages under fire exposure are designed in accordance with EN 1992 – 1- 2:2004+AC:2008

Installation:

- Dry or wet concrete.
- It must not be installed in flooded holes.
- Hole drilling by hammer drill (HD), hollow drill (HDB) or compressed air drill mode (CD).
- The installation of post-installed rebar resp. tension anchors shall be done only by suitable trained installer and under supervision on site; the conditions under which an installer may be considered as suitable trained and the conditions for supervision on site are up to the Member States in which the installation is done.
- Check the position of the existing rebars (if the position of existing rebars is not known, it shall be determined using a rebar detector suitable for this purpose as well as on the basis of the construction documentation and then marked on the building component for the overlap joint).

Chemfix 100 and Chemfix 600 Injection System for rebar connection

Intended use
Specifications

Annex B1

Figure B1: General construction rules for post-installed rebars

- Only tension forces in the axis of the rebar may be transmitted.
- The transfer of shear forces between new concrete and existing structure shall be designed additionally according to EN 1992-1-1:2004+AC: 2010.
- The joints for concreting must be roughened to at least such an extent that aggregate protrude.

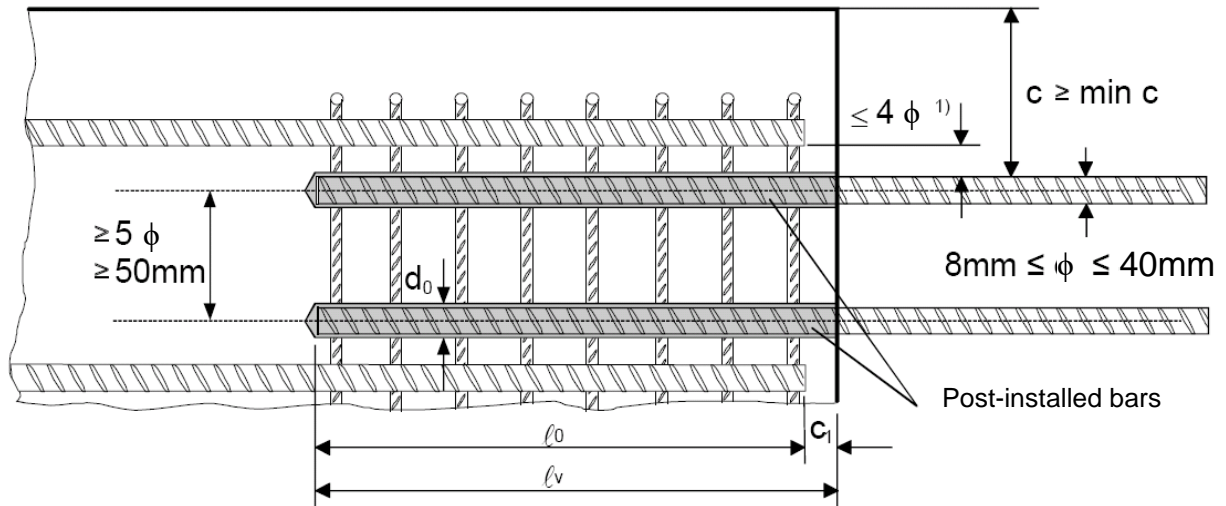

- 1) If the clear distance between lapped bars exceeds 4ϕ , then the lap length shall be increased by the difference between the clear bar distance and 4ϕ .

The following applies to Figure B1:

- c concrete cover of post-installed rebar
- c₁ concrete cover at end-face of existing rebar
- min c minimum concrete cover according to Table B1 and to EN 1992-1-1:2004+AC:2010, Section 4.4.1.2
- φ diameter of post-installed rebar
- l₀ lap length, according to EN 1992-1-1:2004+AC: 2010, Section 8.7.3
- l_v effective embedment depth, $\geq l_0 + c_1$
- d₀ nominal drill bit diameter, see Annex B5

Chemfix 100 and Chemfix 600 Injection System for rebar connection

Annex B2

Intended use

General construction rules for post-installed rebars

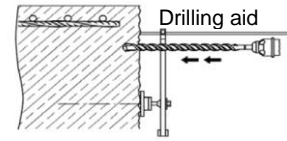
Table B1: Minimum concrete cover $\min c^1)$ of post-installed rebar depending of drilling method

Drilling method	Rebar diameter	Without drilling aid	With drilling aid
Hammer drilling (HD)	< 25 mm	$30 \text{ mm} + 0,06 \cdot l_v \geq 2 \phi$	$30 \text{ mm} + 0,02 \cdot l_v \geq 2 \phi$
	$\geq 25 \text{ mm}$	$40 \text{ mm} + 0,06 \cdot l_v \geq 2 \phi$	$40 \text{ mm} + 0,02 \cdot l_v \geq 2 \phi$
Compressed air drilling (CD)	< 25 mm	$50 \text{ mm} + 0,08 \cdot l_v$	$50 \text{ mm} + 0,02 \cdot l_v$
	$\geq 25 \text{ mm}$	$60 \text{ mm} + 0,08 \cdot l_v$	$60 \text{ mm} + 0,02 \cdot l_v$

¹⁾ see Annex B2 & Figures B1

Comments: The minimum concrete cover acc. EN 1992-1-1:2004+AC:2010 must be observed

Table B2: maximum embedment depth $l_{v,max}$

Rebar ϕ	$l_{v,max}$ [mm]
8 mm	750
10 mm	750
12 mm	750
14 mm	750
16 mm	750
18 mm	750
20 mm	750
22 mm	750
24 mm	750
25 mm	750
28 mm	750
32 mm	750
36 mm	750
40 mm	750

Table B3: Base material temperature, gelling time and curing time

Concrete temperature	Gelling working time ¹⁾	Minimum curing time in dry concrete	Minimum curing time in wet concrete
+ 5 °C	70 min ²⁾	48 h	96 h
+ 10 °C	32 min ²⁾	40 h	80 h
+ 15 °C	28 min ²⁾	30 h	60 h
+ 20 °C	25 min ²⁾	18 h	36 h
+ 25 °C	22 min ²⁾	17 h	34 h
+ 30 °C	20 min ²⁾	16 h	32 h
+ 40 °C	18 min ²⁾	12 h	24 h

¹⁾ t_{gel} : maximum time from starting of mortar injection to completing of rebar setting.

²⁾ Cartridge temperature **must** be at minimum +15°C

Chemfix 100 and Chemfix 600 Injection System for rebar connection





Annex B3

Intended use

Minimum concrete cover

Maximum embedment depth / working time and curing times

Table B4: Dispensing tools

Resin injection pump details		
Image	Size Cartridge	Type
	400 ml 1:1 600 ml 1:1 385 / 585 ml 3:1	Manual
	250 / 280 / 300 ml	Manual
	400 ml 1:1 600 ml 1:1 385 / 585 ml 3:1 7.4v Tool	Battery
	400 ml 1:1 600 ml 1:1 385 / 585 ml 3:1 250 / 280 / 300 ml	Pneumatic
	1400 ml 3:1 1500 ml 1:1	Pneumatic

Chemfix 100 and Chemfix 600 Injection System for rebar connection

Annex B4Intended Use
Dispensing tools

A) Bore hole drilling

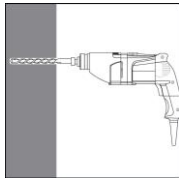

1 Drill a hole into the base material to the size and embedment depth required by the selected reinforcing bar with carbide hammer drill (HD) or a compressed air drill (CD). In case of aborted drill hole: the drill hole shall be filled with mortar.



Hammer drill (HD)

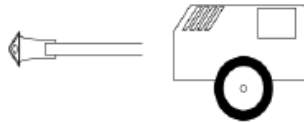

Compressed air drill (CD)

Rebar - ϕ	Drill - \varnothing [mm]
8 mm	12 or 14
10 mm	12 or 14
12 mm	14 or 16
14 mm	18
16 mm	20
18 mm	22
20 mm	25
24 mm	32
25 mm	32
28 mm	35
32 mm	40
36 mm	45
40 mm	55

B) Bore hole cleaning (HD and CD)

MAC: Cleaning for bore hole diameter $d_0 \leq 18\text{mm}$ and bore hole depth $h_0 \leq 10d_s$

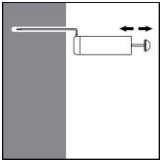

2a. Starting from the bottom or back of the bore hole, blow the hole clean a hand pump (Annex B6) a minimum of 2 times.

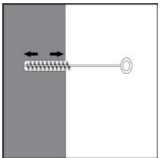

2b. Check brush diameter (Table B5). Brush the hole with an appropriate sized wire brush $> d_{b,\text{min}}$ (Table B5) a minimum of 2 times in a twisting motion. If the bore hole ground is not reached with the brush, a brush extension shall be used.

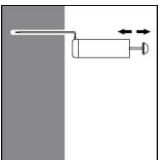

2c. Blow starting from the bottom or back of the bore hole a minimum of 2 times.

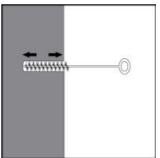

2d. Brush the hole with an appropriate sized wire brush a minimum of 2 times in a twisting motion. If the bore hole ground is not reached with the brush, a brush extension shall be used.

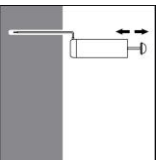

2e. Finally blow the hole clean again with a hand pump (Annex B6) a minimum of 2 times.

Chemfix 100 and Chemfix 600 Injection System for rebar connection

Annex B5

Intended Use

Installation instruction: Bore hole drilling and Bore hole cleaning

CAC: Cleaning for all bore hole diameter and bore hole depth

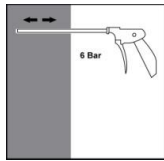

2a. Starting from the bottom or back of the bore hole, blow the hole clean with compressed air (min. 6 bar) (Annex B6) a minimum of 2 times until return air stream is free of noticeable dust. If the bore hole ground is not reached an extension shall be used.

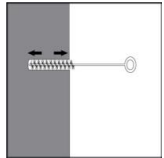

2b. Check brush diameter (Table B5). Brush the hole with an appropriate sized wire brush $> d_{b,min}$ (Table B5) a minimum of 2 times. If the bore hole ground is not reached with the brush, a brush extension shall be used (Table B5).

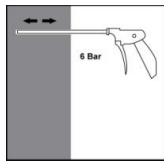

2c. Finally blow the hole clean again with compressed air (min. 6 bar) (Annex B6) a minimum of 2 times until return air stream is free of noticeable dust. If the bore hole ground is not reached an extension shall be used.

Table B5: Cleaning tools

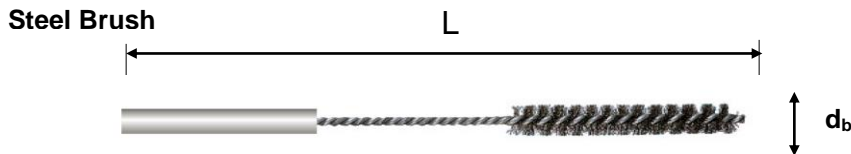

Brush extension:



ϕ Rebar (mm)	d_0 Drill bit - ϕ (mm)	d_b Brush - ϕ (mm)	Manual cleaning	Compressed air cleaning
				YES
8	12 or 14	12 or 14	YES ($h_{ef} \leq 80\text{mm}$)	YES
10	12 or 14	12 or 14	YES ($h_{ef} \leq 100\text{mm}$)	YES
12	14 or 16	14 or 16	YES ($h_{ef} \leq 120\text{mm}$)	YES
14	18	18	YES ($h_{ef} \leq 140\text{mm}$)	YES
16	20	20	NO	YES
18	22	22	NO	YES
20	25	25	NO	YES
22	28	28	NO	YES
24	32	32	NO	YES
25	32	32	NO	YES
28	35	35	NO	YES
30	37	37	NO	YES
32	40	40	NO	YES
36	45	45	NO	YES
40	55	55	NO	YES



Push Pump



**Rec. compressed air tool
hand slide valve (min 6 bar)**

Chemfix 100 and Chemfix 600 Injection System for rebar connection

Intended Use

Installation instruction: Bore hole cleaning
Cleaning tools and

Annex B6

C) Preparation of bar and cartridge

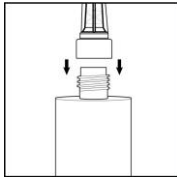

3. Attach the supplied static-mixing nozzle to the cartridge and load the cartridge into the correct dispensing tool.
For every working interruption longer than the recommended working time (Table B3) as well as for every new cartridges, a new static-mixer shall be used.

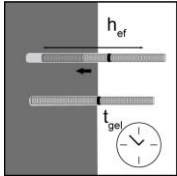

4. Prior to inserting the reinforcing bar into the filled bore hole, the position of the embedment depth shall be marked (e.g. with tape) on the reinforcing bar and insert bar in empty hole to verify hole and depth l_v .
The reinforcing bar should be free of dirt, grease, oil or other foreign material.

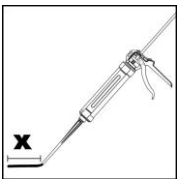

5. Prior to dispensing into the anchor hole, squeeze out separately the mortar until it shows a consistent grey colour, but a minimum of three full strokes, and discard non-uniformly mixed adhesive components.

D) Filling the bore hole

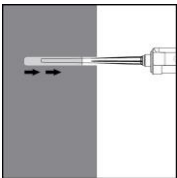

6. Starting from the bottom or back of the cleaned anchor hole fill the hole up to approximately two-thirds with adhesive. Slowly withdraw the static mixing nozzle as the hole fills to avoid creating air pockets.

Observe the gel-/ working times given in Table B3.

Table B6: Maximum anchorage depth and mixer extension

Bar size ϕ [mm]	Drill bit - \emptyset HD [mm]		Cartridge: All sizes			
			Hand or battery tool		Pneumatic tool	
	$l_{v,max}$ [mm]	Mixer extension Short/Long	$l_{v,max}$ [mm]	Mixer extension Short/Long		
8	12	14	360	Short	360	Short
			750	Short + Long	750	Short + Long
10	12	14	360	Short	360	Short
			750	Short + Long	750	Short + Long
12	14	16	360	Short	360	Short
			750	Short + Long	750	Short + Long
14	18		180	-	180	-
			360	Short	360	Short
			750	Short + Long	750	Short + Long
16	20		750	Short + Long	750	Short + Long
18	22					
20	25					
22	28					
24	32					
25	32					
28	35					
32	40					
36	45					
40	55					

Chemfix 100 and Chemfix 600 Injection System for rebar connection

Intended Use

Installation instruction: Preparation of bar and cartridge
Filling the bore hole

Annex B7

Mixer Extension Short



Mixer Extension Short + Long



E) Inserting the rebar

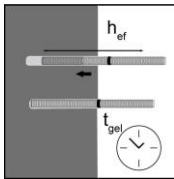

7. Push the reinforcing bar into the anchor hole while turning slightly to ensure positive distribution of the adhesive until the embedment depth is reached.

The bar should be free of dirt, grease, oil or other foreign material.

8. Be sure that the bar is inserted in the bore hole until the embedment mark is at the concrete surface and that excess mortar is visible at the top of the hole. If these requirements are not maintained, the application has to be renewed. For overhead installation fix embedded part (e.g. wedges).

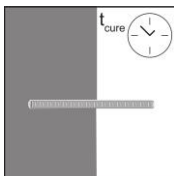

9. Observe gelling time t_{gel} . Attend that the gelling time can vary according to the base material temperature (see Table B3). It is not allowed to move the bar after gelling time t_{gel} has elapsed. Allow the adhesive to cure to the specified time prior to applying any load. Do not move or load the bar until it is fully cured (attend Table B3). After full curing time t_{cure} has elapsed, the add-on part can be installed.

Chemfix 100 and Chemfix 600 Injection System for rebar connection

Annex B8

Intended Use

Installation instruction: Filling the bore hole
Inserting rebar

Minimum anchorage length and minimum lap length

The minimum anchorage length $\ell_{b,min}$ and the minimum lap length $\ell_{0,min}$ according to EN 1992-1-1:2004+AC:2010 ($\ell_{b,min}$ acc. to Eq. 8.6 and Eq. 8.7 and $\ell_{0,min}$ acc. to Eq. 8.11) shall be multiply by the amplification factor α_{lb} according to Table C1.

The design bond strength f_{bd} according to EN 1992-1-1:2004+AC:2010 (Eq.8.3) shall be multiplied by the factor k_b according to Table C2 to determine the design values of the ultimate bond stress for post installed rebars $f_{bd,PIR}$, which are given in Table C3.

Table C1: Amplification factor α_{lb} related to concrete class and drilling method

Concrete class	Drilling method	Rebar size	Amplification factor α_{lb}
C12/15 to C45/55	Hammer drilling (HD) and compressed air drilling (CD)	8 mm to 25 mm	1,0
C50/60	Hammer drilling (HD) and compressed air drilling (CD)	8 mm to 25 mm	1,1
C12/15 to C50/60	Hammer drilling (HD) and compressed air drilling (CD)	28 mm to 40 mm	1.0

Table C2: Bond efficiency factor k_b

Rebar - \emptyset	Concrete class								
	C12/15	C16/20	C20/25	C25/30	C30/37	C35/45	C40/50	C45/55	C50/60
ϕ									
8 to 25 mm						1,0	1,0	1,0	1,0
28 to 36 mm	1,0	1,0	1,0	1,0	1,0			0,93	0,93
40 mm						0,88	0,81	0,85	0,79

Table C3: Design values of the ultimate bond stress $f_{bd,PIR}$ in N/mm² for all drilling methods for good conditions

according to EN 1992-1-1:2004+AC:2010 for good bond conditions
(for all other bond conditions multiply the values by 0.7)

Rebar - \emptyset	Concrete class								
	C12/15	C16/20	C20/25	C25/30	C30/37	C35/45	C40/50	C45/55	C50/60
ϕ									
8 to 25 mm						3,4	3,7	4,0	4,3
28 to 36 mm	1,6	2,0	2,3	2,7	3,0			3,7	4,0
40 mm						3,0	3,0	3,4	3,4

Chemfix 100 Injection System for rebar connection

Performances

Amplification factor α_{lb}
Design values of ultimate bond resistance $f_{bd,PIR}$

Annex C1

Design value of the ultimate bond stress $f_{bd,fi}$ under fire exposure for concrete classes C12/15 to C50/60, (all drilling methods):

The design value of the bond strength $f_{bd,fi}$ under fire exposure has to be calculated by the following equation:

$$f_{bd,fi} = k_{fi}(\theta) \cdot f_{bd,PIR} \cdot \gamma_c / \gamma_{M,fi}$$

$f_{bd,fi}$ Design value of the ultimate bond stress in case of fire in N/mm²

$$k_{fi}(\theta) = \frac{10151 \cdot \theta^{-1,791}}{f_{bd,PIR} \cdot 4,3} \leq 1,0 \quad \theta \leq 172^\circ\text{C}$$

$$k_{fi}(\theta) = 0 \quad \theta > 172^\circ\text{C}$$

θ Temperature in °C in the mortar layer.

$k_{fi}(\theta)$ Reduction factor under fire exposure.

$f_{bd,PIR}$ Design value of the ultimate bond stress in N/mm² in cold condition according to Table C3 considering the concrete classes, the rebar diameter, the drilling method and the bond conditions according to EN 1992-1-1.

γ_c partially safety factor according to EN 1992-1-1

$\gamma_{M,fi}$ partially safety factor according to EN 1992-1-2

For evidence under fire exposure the anchorage length shall be calculated according to EN 1992-1-1:2004+AC:2010 Equation 8.3 using the temperature-dependent ultimate bond stress $f_{bd,fi}$.

Example graph of Reduction factor $k_{fi}(\theta)$ for concrete classes C20/25 for good bond conditions:

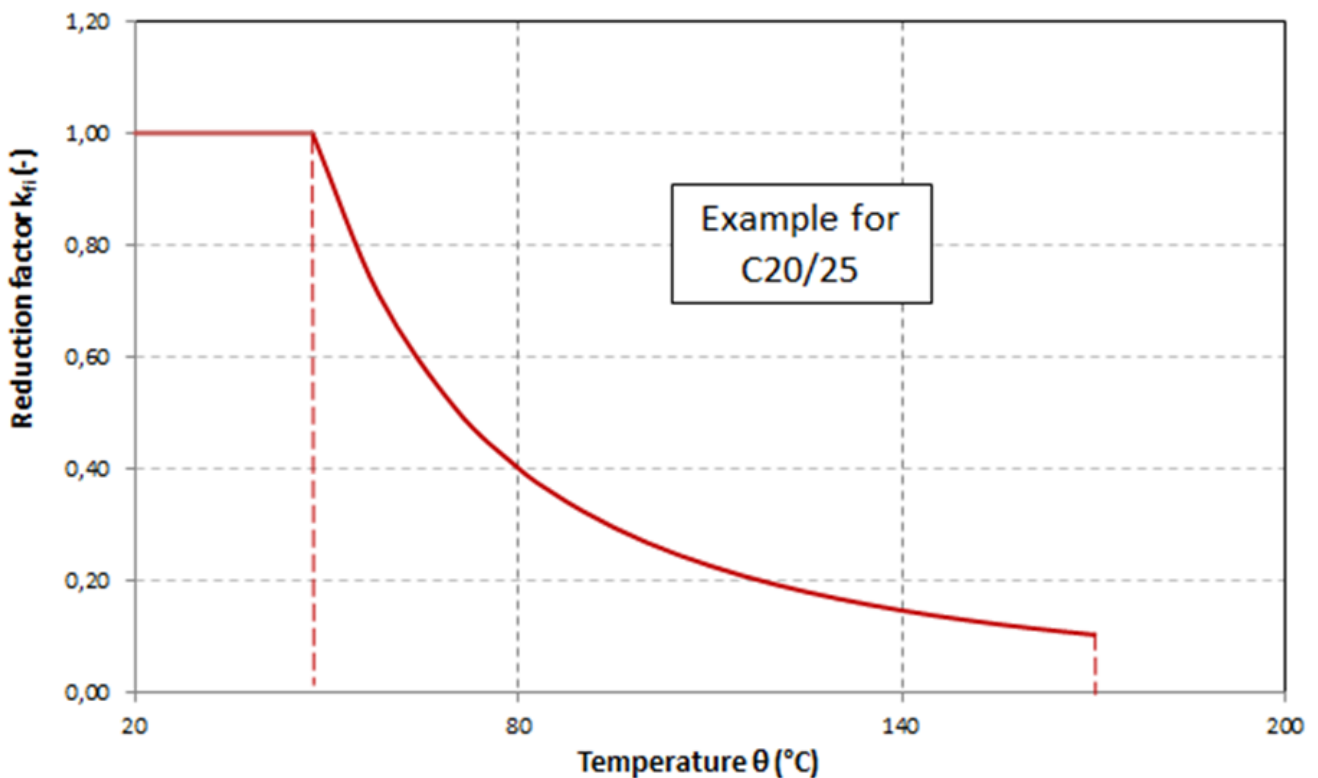

Chemfix 100 Injection System for rebar connection

Annex C2

Performances

Design value of bond strength $f_{bd,fi}$ under fire exposure